

Framery Magazine



ISSUE 7
The work-comfort issue

Brought to you by the
world's leading office
pod company

This is Framery

Framery is the pioneer and world's leading manufacturer of acoustic pods, phone booths and soundproof private spaces for solving noise and privacy issues in offices and other venues.

Our products make employees more productive and successful in the offices of many of the world's leading companies, including Nvidia, Puma and Microsoft. In fact, around 70% of all 'Forbes Top 100' companies use Framery products. In 2024, our revenue was 154 million euros. In the next few years our growth is projected to strongly increase.

We employ over 430 people in 18 countries, with end customers in across 89 different countries in all inhabited continents. Our headquarters is in Tampere, Finland, where around 90% of us work.

Our product family is made from durable, renewable and recyclable materials and our pods are designed to have a long lifespan. With a strong focus on research and development, as well as a firm commitment to practicing what we preach, we remain determined to find the keys to overall work-life success—in a sustainable manner.

Contents

PART ONE

DESIGNING THE OFFICE OF THE FUTURE

Reimagining spaces and confronting distractions through flexible design

RETHINKING THE MODERN OFFICE

From a simple request to a global phenomenon—Framery celebrates 15 years since inventing the office pod

MEET THE NEW FRAMERY SMART PODS

Our new line of smart pods that have been designed to make every part of your workday easier

CASE STORY PUISTOKOULU

Making space for every mind—redefining neuroinclusive education with Framery pods

REVOLUTIONIZE YOUR WORKPLACE

Meet the Framery smart pods

DESIGN HIGHLIGHT | FRAMERY ONE LOUNGE

Business as usual. Comfort on a new level.



Issue 07

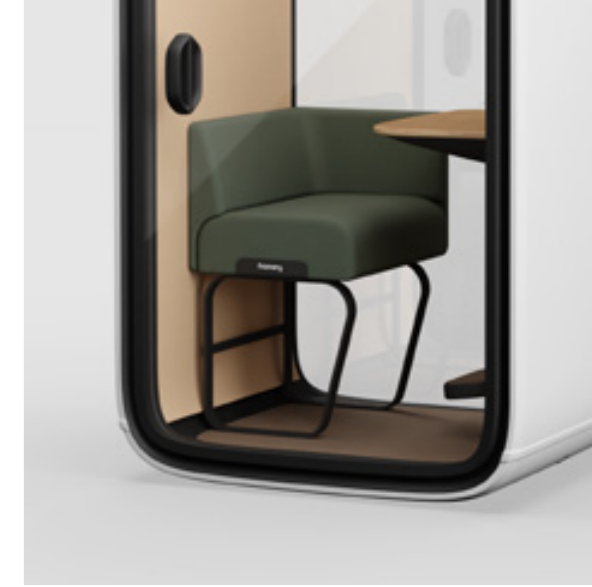

PART TWO

CASE STORY | INDERES

How Inderes built a smarter office with Framery smart office solutions

CARBON HANDPRINT STUDY

A 360 approach to sustainability

SUSTAINABILITY WITH IMPACT

Fossil free steel

PART THREE

SET YOUR OFFICE UP FOR SUCCESS

Workplace technology that changes how your office operates

FRAMERY PRODUCTS

From one person pods to full-sized meeting rooms

MATERIALS AND SUSTAINABILITY

Design and durability that's measured in decades

PRODUCT SAFETY

Parameters that meet or exceed global standards

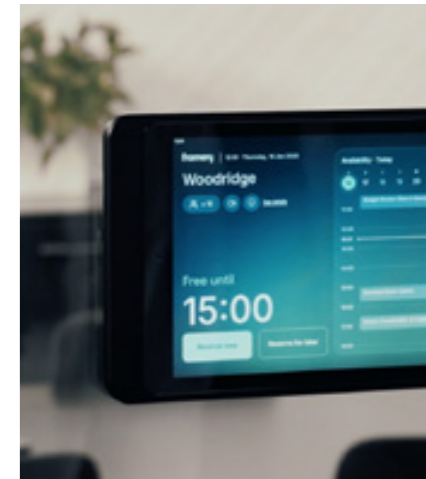
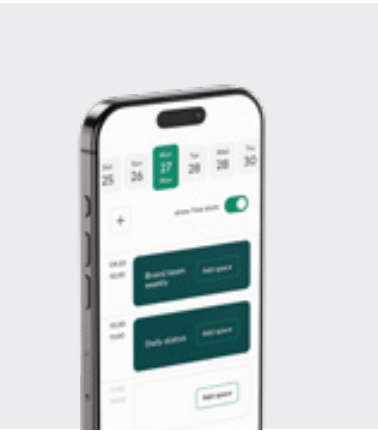



PART ONE

Designing the office of the future

Office design is on path towards transformation. With evolving needs of modern work, and shifting attitudes towards the Return to Office trend, offices will continue to change and adapt to the needs of the worker. Here's a look at what factors will affect workplaces of the future—all around the world.

Back to basics

The idea of a supportive office will shift towards the core needs of the workers. And investing in the basic elements has the most impact. Modern offices need spaces that echo the comfort and functionality of home offices—spaces that employees actually want to return to.

Now, more than ever, essentials are central to modern office work. Employees demand well-thought-out spaces that cater to concentrated work. These are no longer mere amenities—they are essential tools that enable productivity and well-being.

Distractions are everywhere

Distractions will become more burdensome to workers than ever. Offices can no longer leave it to the employees to solve their privacy problems. Infrastructure must shift to better accommodate workers. To affect change, offices must move the focus from the individual to the infrastructures within which they operate. This includes the physical structures of the workspace.

The office of the future must be an ally in the war against distractions, not a battleground. The goal is to create spaces that support concentration rather than disrupt it. This is especially important for neurodivergent individuals who may face more challenges with attention management.

Flexibility is key

Flexible arrangements promote productivity. To survive, offices need to become destination offices, or office magnets. Places that employees are drawn to not out of obligation, but out of a genuine desire to work within

the four walls and meet their colleagues. A destination that is worth the commute and the convenience of the home office.

They require spaces that are able to adapt to the needs of in-person work—as well as sessions with remote colleagues or clients. And they must address the need for both privacy and social connection.

Focus spaces are crucial

Offices need to begin providing more spaces for focused work. Office design must include areas that mitigate distractions. As tasks become increasingly complex, the need for environments that cater to high concentration and minimization of distractions becomes evident.

Spaces where distractions are minimized and people get work done are a key factor for the office—not just a nice bonus. A workspace that does not support focused work, is an "obstructor" workspace. If a workspace doesn't support focused working, it won't matter how brilliant the other spaces are.

Make them an office they can't refuse

The office is not merely a physical place—it's a constantly evolving ecosystem. And offices need to begin to be seen as an equal part of the team. That means flexible, available spaces where people can focus on the things that actually matter. And turn the office into a place for people to get things done.

RETHINKING THE MODERN OFFICE

15 years of inventing quiet—how Framery created the office pod

FRAMERY, the office pod pioneer, is proud to announce its 15th anniversary, a milestone that also marks 15 years since the company invented the office pod, sparking a new industry and fundamentally changing how millions work.



Learn all about our smart pods and office solutions

framery.com



more models and continuous innovation. In 2013, Framery launched the Framery O, the first pod to achieve a 30dB speech reduction.

Since those humble beginnings, Framery has grown exponentially, becoming synonymous with high quality and effective soundproof spaces. What started as a solution for a few colleagues is now a necessity for millions of knowledge workers in over 100 countries, utilized by most of the world's leading companies, including industry giants like Nvidia, Puma, BCG and Microsoft. Today, approximately 70% of all Forbes Top 100 companies rely on Framery's products to create more functional and productive workspaces.

Last year marked the most significant milestone for the office pod industry since Framery invented the product category with the launch of the first smart pod. Building upon Framery's renowned acoustic privacy, these next-generation pods incorporate smart office solutions that address the most pressing challenges of today's hybrid work environments.

Founded in 2010, Framery was born out of the shared frustrations of working in a distracting open-plan office environment. Samu Hällfors, CEO and co-founder, then in his early twenties and working in an open-plan office, experienced firsthand the challenges of maintaining focus amidst constant noise. "The constant noise, particularly from our boss's phone calls, was incredibly frustrating," recalls Hällfors. "My friend and I suggested he take his calls elsewhere, and he responded, "Well, buy me a phone booth."

The request ignited an idea. Since no such options existed, Framery's founders recognized a big opportunity. In their garage, they built the first office pod prototype, affectionately named "Pömpeli" (a Finnish word for "box"). This became the world's first commercial office pod, launched in 2010. It not only met a key need for quiet but also created a whole new product category and the company Framery. This led to

The new user-focused features of our smart pods support a culture of hybrid work—making it easier than ever to get things done at the office.

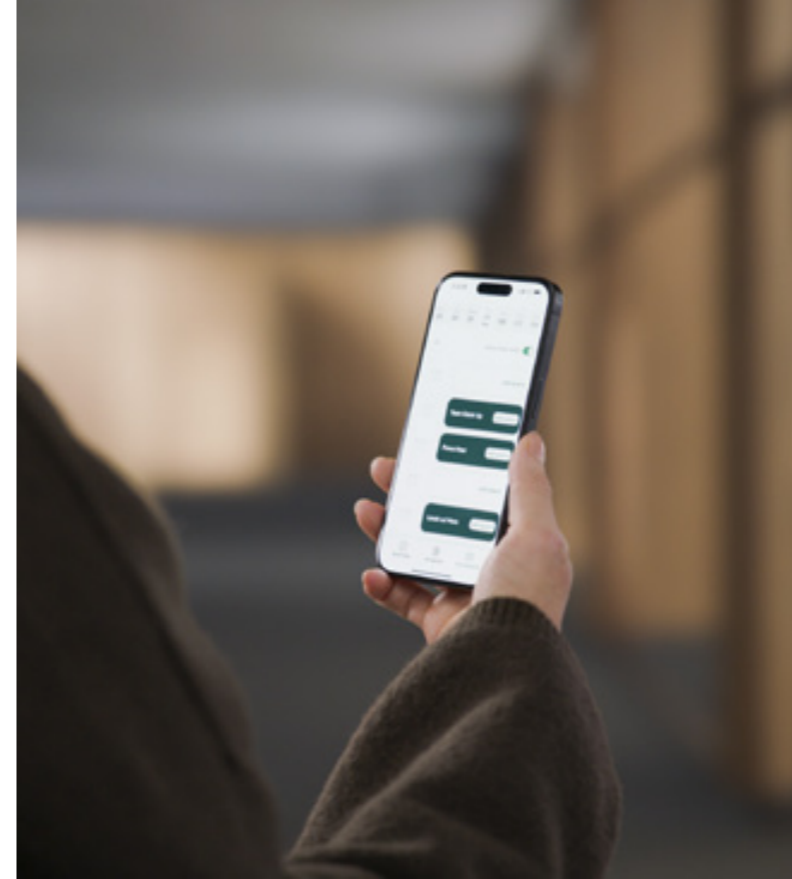

"This seamless fusion of smart features with our physical pod design became a true catalyst for the industry."

SAMU HÄLLFORS
CEO AND CO-FOUNDER
FRAMERY

"This seamless fusion of smart features with our physical pod design became a true catalyst for the industry," says Samu Hällfors. "Just as smart features have become standard in many other product categories, we saw this as an expected and necessary evolution for office pods to truly support the modern workplace."

Celebrating 15 years since creating the office pod industry, Framery views this milestone as a launchpad for future innovation and leadership. What began in a garage has become integral to modern workspace design, and Framery continues to drive the evolution of how we work.

ABOUT FRAMERY

Framery is the global leader in soundproof pods and smart office solutions, enabling people to focus on what truly matters and get things done. Framery is a necessity for a successful workday for millions of knowledge workers in over 100 countries and within most of the world's leading companies including Nvidia, Puma, and Microsoft. In fact, around 70% of all Forbes Top 100 companies use our products.





Making space for every mind—redefining neuroinclusive education with Framery pods

At Framery, we've always believed that the spaces we design shape the lives we live. And sometimes, changing a life starts with creating just a little bit of quiet.

Earlier this year, we partnered with Puistokoulu, a special needs school in our hometown of Tampere, to donate a custom Framery Four pod—a space where students can breathe easier, focus better, and feel more at ease in their day-to-day routines.

But this donation wasn't just about adding a piece of furniture—it was about reinforcing a belief that has always been central to our work: neuroinclusion isn't a feature; it's a foundation.

Empowering neurodiverse learners in the Tampere community

Puistokoulu isn't a typical school. It's a place designed around the needs of neurodivergent learners—students

who may live with ADHD, autism spectrum conditions, emotional regulation challenges, or other neurological differences that make traditional classrooms a difficult fit.

With small class sizes, predictable routines, therapeutic support, and calming design elements, Puistokoulu creates an environment where students are supported holistically. Here, every child is treated as an individual—with the space, structure, and compassion they need to succeed.

When the school's leadership team expressed a need for a quiet, flexible space to support both teaching and learning, we knew the Framery Four would be the perfect fit.

What makes a space inclusive?

Just like neurodivergent employees, students across the spectrum of neurodiversity benefit from environments that reduce sensory overload and support self-regulation. In fact, according to a 2024 Leesman Report, 63% of neurodivergent employees say their needs are rarely met in open-plan environments—spaces filled with noise, interruptions, and limited control over one's surroundings.

This isn't just an office problem. A 2023 study by Creary et al. found that neurodivergent individuals are twice as likely to report poor focus in environments with

constant noise or social interaction. That insight directly informed our approach to customizing the Framery Four for Puistokoulu's students.

Framery pods are private, enclosed spaces that foster emotional regulation and autonomy—which is especially important for students managing sensory sensitivities or anxiety. As a 2021 study by the Finnish Institute of Occupational Health found, quiet environments reduce physiological stress and help protect emotional and cognitive resources—promoting healthier, long-term performance.

A supportive space for students and teachers alike

Since arriving in March 2025, the pod has quickly become an integral part of daily life at Puistokoulu. Teachers use it for calm one-on-ones, small group lessons, and personalized learning support. Students use it to read, reset, or regulate their emotions when things get overwhelming.

"The pod offers a sense of safety and privacy," says one Puistokoulu teacher. "It's something both our staff and students value every day."

It's a space that meets students where they are—without requiring them to ask. That kind of support from an early age is crucial—especially when so many neurodivergent individuals feel unable to advocate for their needs.

A 2024 Neurodiversity at Work report revealed that 42% of neurodivergent employees feel uncomfortable requesting adjustments in the workplace. That reluctance often starts in school, where visible accommodations can carry stigma—making universal, non-stigmatizing support systems like this all the more essential.

Framery pods help address this by offering visible and non-stigmatizing support—available to all, without formal disclosure. That's inclusion by design.

Inclusive support that lasts a lifetime

When we create environments that support neurodiverse learners today, we're also investing in more inclusive workplaces tomorrow. Because the need for neuroinclusion doesn't stop after graduation.

According to the 2024 Neurodiversity at Work report, 66% of neurodivergent employees say their experiences improve, and that they're more likely to stay, when workplace adjustments are in place. And as Deloitte's 2022 Neurodiversity and the Future of Work study emphasizes, neuroinclusive environments don't

just benefit individuals—they lead to stronger teams and better organizational outcomes overall.

By giving students access to these types of supportive spaces early in life, we're helping them build confidence, autonomy, and focus that they'll carry into the future—reinforcing a long-term vision of inclusion that begins in education and continues through every stage of life.

Designing with purpose. Giving with impact.

Framery's partnership with Puistokoulu reflects our ongoing commitment to communities, inclusion, and impact. Whether in a classroom or a corporate office, we believe everyone deserves a space that supports their success—without needing to ask for it.

This donation is just one example of how thoughtful design and inclusive environments can make a real difference for neurodivergent individuals, and the communities they're part of. Because building spaces that work for every kind of mind isn't just the future of education or work—it's the future of good design.

The pod offers a sense of safety and privacy for both staff and students.



66%

66% of neurodivergent employees say their experiences improve, and that they're more likely to stay, when workplace adjustments are in place

THE NEURODIVERSITY AT WORK REPORT, 2024

63%

63% of neurodivergent employees say their needs are rarely met in open-plan environments

THE LEESMAN REPORT, 2024

42%

42% of neurodivergent employees feel uncomfortable requesting adjustments in the workplace.

THE NEURODIVERSITY AT WORK REPORT, 2024

REVOLUTIONIZE YOUR WORKPLACE

Meet the Framery smart pods

Our new line of smart pods have been designed to make every part of your workday easier—from effortlessly locating and reserving pods to maximizing productivity throughout your day.



A-CLASS SOUNDPROOFING

30dB

Guaranteed privacy with fine-tuned Class A speech level reduction and the industry's top rating for office phone booths

MEDIAN AUTOMATED AIRFLOW

60 sec

Air inside the pod is fully renewed every 60 seconds

MATERIAL EFFICIENCY

95%

Our own production material efficiency rate was 95% in 2024

A suite of cutting-edge technology and software allow our new smart pods to sense and respond to environmental conditions, provide behavioral data for optimizing office layouts, and stay connected to every space in the workplace with advanced bookability functionalities.

With an integrated 4G connection, the pods can receive over-the-air software upgrades to integrate new features into the future.

Made from steel, aluminum and glass, these new smart pods improve upon the world-class soundproofing, industry-leading ventilation, and captivating design that have established Framery pods the global benchmark in quality and innovation.

Innovation in action

We strived to create a family of products with never-before-seen capabilities. Based on the success of Framery One, the design team worked to create pods for teams and larger groups of people. The result is an entire family of pods that feature innovative and proprietary technology, combined together in a sleek and sophisticated package.

The integrated technology merges sophisticated hardware with newly developed software, enhancing functionality and capabilities across the entire range of smart pods—and the offices they inhabit.

mmWave Radar detection

Millimeter-wave radar sensors immediately detect when someone enters or leaves the pod, allowing lighting and ventilation to adjust accordingly.

The Framery Office Sound Masking System™

Embedded sound masking uses a proprietary sound spectrum to reduce speech intelligibility and noise distractions in areas outside of the pods.

Fine-tuned soundproofing

A patent-pending acoustic structure tuned to human speech frequency provides A-class soundproofing with minimal material.

Automated reservations

Create a reservation in the pod simply by stepping inside—and extend your booking with a single touch.

Adaptive airflow

Choose between direct or indirect airflow and adjust the ventilation to your comfort.

Advanced ventilation technology

Sensors inside the pod recognize the temperature and humidity of the office environment, and automatically optimize the airflow accordingly.

Real-time usage data

Real-time usage data is collected by the pod to make it easy for office managers to see when the pods are being used, and enables on-the-fly booking.

Intuitive user experience

An 8-inch, high-resolution touchscreen makes it easy to control pod settings, adjust lighting and airflow, and extend calendar reservations.

Automatic upgrades

A built-in 4G connection enables automatic upgrades and over-the-air software updates with or without a Wi-Fi connection.

Occupancy indication

Lights on the exterior of the pod let you see from a distance whether the pod is free, booked, or about to become available.

The Framery app

Make every pod and space in your office easy to find and book through the Framery app—in advance or on the go.

Acoustic ventilation channels

Incoming air is routed through acoustically optimized ventilation channels to improve soundproofing and reduce noise transference.

Optimized lighting

Automated lighting with two preset lighting modes ideally adjusted for in-person work or video calls.

Sustainable engineering

Designed and built sustainably, the new smart pods use less materials, favoring aluminum and steel over wood. The result is a pod that is 25% lighter, making them easier to ship, build, and move.



Building on our past

Our new smart, soundproof workspaces don't compromise. Like the Framery pods before them, they are a blend of style, functionality, and sustainability—all enhanced by new technology. This approach has allowed us to use our past experiences to build pods for the future.

Framery design DNA

These modern office pods feature a timeless design approach—with clean lines, spacious interiors, and a polished finish.

User-focused

The broad glass surfaces and minimalistic frames increase the feeling of spaciousness inside the pod, and ergonomic furniture provides comfort for every user.

Extended lifecycle

A new modular, more durable design, and replaceable elements, means the smart pods have a longer

lifespan. And recycling at the end of the pod's lifecycle is even easier due to the materials used.

Safety certification

All of Framery's smart pods have gone through a rigorous certification and compliance programs for fire, electrical and seismic safety.

A pod for every office

We aim to make offices better for people all around the world. Despite incorporating advanced technology, our products remain competitively priced and affordable for offices everywhere. In addition to being the most advanced soundproof office pods in the world, our innovative smart pods are sustainable, cost-effective, and designed for modern work.

Welcome to the future of office design with Framery smart pods and Framery smart office solutions.

Business as usual. Comfort on a new level.



that replaces the original stool and electric desk with an ergonomic sofa and fixed-height table. This new interior reimagines the experience of Framery One as a space custom-crafted for productivity, comfort, rest, and recovery throughout the workday.

Framery One Lounge features the same world-class sound insulation, smart technology, and optimized lighting that established Framery One as the gold standard in office pods. The new interior offers a soft, grounded environment that brings comfort and calm—while preserving the high-performance functionality that teams rely on every day.

“People love using Framery One for video calls, focused tasks, or a moment to regroup,” says Henrik Ashorn, Product Director for Framery One. “Framery One Lounge brings added comfort to those moments and creates a more relaxed, supportive atmosphere.”

Developed with the same quality and precision that define every Framery product, the interior layout in Framery One Lounge was designed for comfort and ease of use. A custom-built elevated sofa supports natural posture—eliminating awkward working angles that aren't suited for extended focus. And a large, fixed-height working table is perfectly positioned to reduce strain—creating an ergonomic and supportive setup for work and rest alike.

This new layout brings even more flexibility to how a one-person pod can be used. An optional monitor mount makes it easy to install a full-sized display directly into the wall above the table—transforming Framery One Lounge into a dedicated space for video calls, content sharing, or focused screen work. Combined with Framery's optimized lighting and acoustic performance, it's a clean and spacious setup designed for enhanced comfort and confident connection.

“We wanted to design a space that was equally supportive for both focused work and casual relaxation,”

The world's best-selling smart pod is now even more versatile thanks to a newly available interior layout option.

Designed to redefine solo workspaces—the Framery One Lounge. This new interior option for the popular Framery One shifts the mood inside the pod with a custom-designed sofa—creating a private workstation that doubles as a space to pause, reset, and reflect.

Framery One has become a favorite in modern offices as a sleek and soundproof one-person workstation ideal for uninterrupted calls and extended solo sessions. Framery One Lounge introduces a new layout option

says Ashorn. “The layout of Framery One Lounge supports a grounded, confident, and natural presence. It's a space that feels open and balanced on the inside, while retaining a minimal footprint in the office.”

Smart. Comfortable. Versatile. Framery One Lounge redefines what a solo pod can be—without compromising what made it a favorite in the first place. It's a natural next step in the evolution of solo workspaces—and a reflection of a workday that values preservation as much as performance and productivity.

Three clever layouts. One smart pod.

Framery One is now available in three distinct layouts—giving you even more control over how you want to work.

Framery One Base

The world-class smart pod without a stool—so there's room to stand or add your own.

Framery One Premium

Advanced ergonomics from a height-adjustable seat & dual footrests.

Framery One Lounge

Ultimate comfort from a custom-designed sofa and padded footstool.



Additional options & upgrades

Get even more out of Framery One with these optional add-ons

Add a Screen to Framery One

Framery One monitor wall mount lets you add a full-sized display to any Framery One—freeing up working space.

Retractable Castors

Place the pod anywhere—and move it whenever needed.

Kickplate

A sleek metal kickplate protects the back wall from scuffs and scrapes.

Seismic Kit

Safety compliance for earthquake zones around the world.



How Inderes built a smarter office with Framery smart office solutions



Inderes is a Helsinki-based investment analysis firm and financial media platform known for its strong community-first culture, open communication, and data-driven approach to equity research.

With a mission to democratize financial information, Inderes creates podcasts, webinars, and video content to build a thriving community around finance—making versatile, well-equipped spaces essential to their daily work.

With 120 employees spread between Helsinki and Stockholm, the company recently relocated its Finnish headquarters into a new open-plan office that reflects its collaborative and human-centered values.

The new single-level office brings the whole team together—boosting energy and collaboration, but also creating new challenges with meeting room availability, space conflicts, and privacy.

Building a smarter office with Framery

To avoid a workplace filled with silos, Inderes turned to Framery smart office solutions for everything needed to make their office intuitive, supportive, and easy to manage. Combined with Framery smart pods, they've created a space that supports spontaneous collaboration while still offering enough structure and quiet for focused work.

When planning the move, Inderes explored multiple space management solutions. But most tools were either too expensive, too rigid, or not user-friendly.

Framery stood out for its flexible pricing, seamless Microsoft 365 integration, and responsive support team. According to Typpö: "We were ready to settle for a less-than-ideal solution—until Framery came in with a smarter alternative that made us change course immediately."

A smart solution for a smarter office

Inderes wanted more than just a nice office—they envisioned a fully connected workplace with integrated tools that would make it easier to navigate, manage, and optimize their new space. And Framery's combination of room booking solutions and workplace management tools deliver exactly what they were looking for.

- Framery Connect creates a centralized room booking system that provides valuable workplace analytics about space usage.
- Framery Connect Sensors placed in meeting rooms reveal how effectively they are actually used.
- Framery Room Displays outside meeting spaces show real-time availability of each space.
- Framery App helps employees easily find and book spaces from anywhere.
- Framery smart pods provide private, soundproof spaces in their open-plan office.

"Having everything in one system just makes sense—pods, rooms, displays, and bookings all work together without extra tools or confusion."

These solutions form a smart office where every space works in sync—creating a workplace experience that feels effortless, efficient, and ready for what's next.

Syncing calendars and connecting spaces

Framery's smart office solutions have transformed how Inderes manages its workspaces. All reservations are synced automatically in their Microsoft 365 calendar system—immediately reflecting continuous changes to space availability throughout the day.

"Calendar integration with Microsoft 365 is key—everything stays synced across Outlook and the Framery App."

Keeping all meeting rooms, work spaces, and room displays synced and updated gives employees real-time visibility and a streamlined booking experience—whether they choose to book through Microsoft Outlook or the Framery App.

This level of integration reduces confusion, prevents double bookings, and makes every space easy to find and reserve. The result is an office experience that supports day-to-day productivity—and a smoother workday without scheduling friction or juggling between platforms and tools.

Connecting Inderes through Framery smart office solutions

Implementing Framery's smart office solutions was a smooth, low-effort process for Inderes. With clear onboarding and hands-on support from the Framery team, setup was fast and company-wide adoption followed quickly.

"Framery made the entire process effortless—with fast installation and responsive support from day one."

The real impact, though, comes in how each solution is used every day. From booking rooms to understanding space usage, Framery smart office solutions have been working hard to bring value to both employees and IT.

Staying in sync with Framery Connect

Framery Connect serves as the backbone of Inderes' smart office system. Integrated directly with Microsoft 365, it ensures calendars, pods, and meeting rooms all stay in sync—reducing scheduling conflicts and helping people find and book spaces easily.

"Framery Connect shows how much use our spaces get—it's a great metric to use as we continue to grow."

Through Framery Connect's Analytics feature, IT can access anonymous data about usage rates, peak room occupancy, and visit durations—giving the team a better understanding of how their spaces are being used, and helping them to be proactive with their space planning.

"Framery offered the right balance of flexibility, function, and support. It was everything we needed and nothing we didn't."

TIMO TYPPÖ, IT ADMINISTRATOR



Booking spaces with the Framery App

Framery App has quickly become an employee favorite at Inderes—playing a key role in how the team navigates their workday by offering a quick, intuitive way to check room availability, see their daily calendar, and reserve spaces on the go.

The app's clean design and ease of use have made it quick and easy to onboard the team. And with a seamless connection to their Microsoft 365 calendar, everything booking made through the app is automatically updated in Outlook and on Teams as well.

"People love that the Framery App shows their whole calendar for the day. It's simple, useful, and has become part of how they manage their workflow."

For a company that values autonomy and efficiency, the app helps remove barriers from everyday scheduling. Employees no longer have to guess whether a room is free or switch between multiple systems to coordinate bookings.

Smarter visibility with Framery Room Display

Five Framery Room Displays installed outside the busiest meeting rooms and studio spaces help employees instantly see which rooms are available and when. With a large, clear display that removes any second-guessing about whether a room is in use.

With a team of over 100 people sharing 10 rooms, this small addition has had a big impact—saving time, reducing confusion, and making it easier for everyone to find the space they need, exactly when they need it.

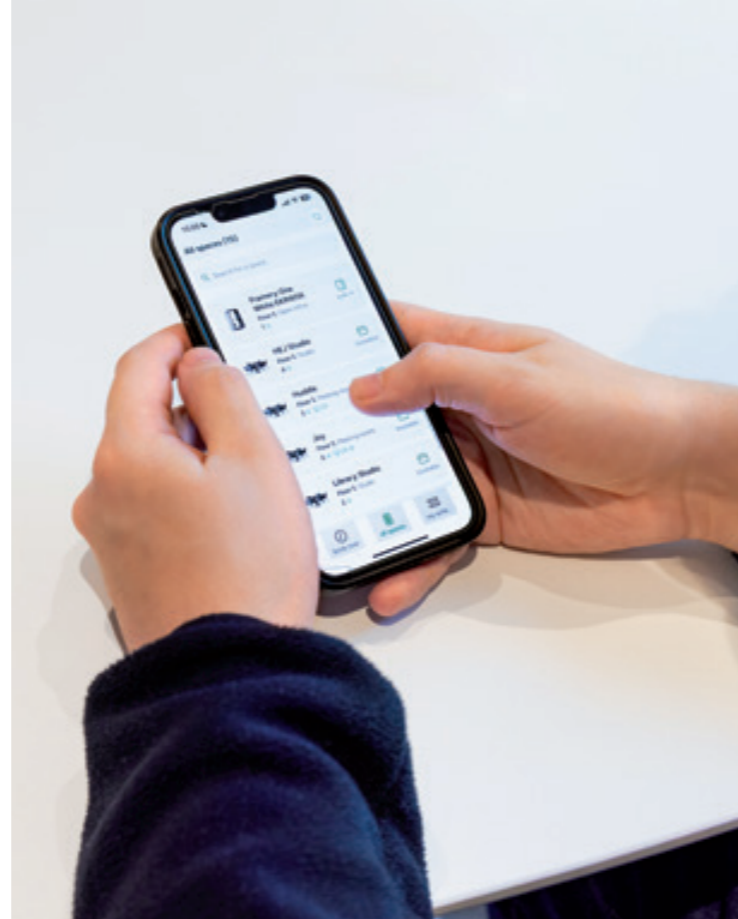

"The Room Display UI has a super clean design. And installation was a breeze."

Installed on standard iPads, the interface of Framery Room Display is "noticeably more intuitive" than competitors. In addition to showing real-time status at a glance, it also welcomes employees to check upcoming schedules for the space, and make a reservation directly on the spot.

The simple but effective design prevents awkward interruptions and keeps meetings running smoothly—making the displays a trusted part of the office routine.

Better decisions with Framery Connect Sensor

With 12 Framery Connect Sensors installed throughout their meeting rooms, Inderes gains access to real-time insights into how spaces are actually being used. These sensors anonymously track occupancy, visit duration, and usage patterns—providing a reliable stream of data to support smarter space management.

Private workspaces can be made available when and where they're needed. With 12 Framery Connect Sensors installed throughout the meeting rooms, Inderes gains access to real-time insights into how spaces are actually being used.

For employees, this means more efficient room availability and fewer conflicts. For Office and IT Managers, it's a valuable tool for identifying underused spaces, and planning future improvements.

"That kind of data gives us the clarity we need to plan ahead."

The data enables Inderes to make informed decisions around layout, resource allocation, and potential expansion—ensuring the office remains adaptable and employee-friendly as the company grows.

Smart solutions for modern offices

When planning their new office, Inderes chose to bring everything together under one unified, smart office platform—rather than stitching together disconnected tools from multiple suppliers. By unifying everything under one intelligent office platform, they created a workspace that's seamless, intuitive, and helps the office get better every day.

For employees, it means less friction and more focus. For IT and management, it means fewer tools to manage and less time spent troubleshooting. Onboarding new users is straightforward, and day-to-day usage feels intuitive—no training manuals required.



"People love that the Framery App shows their whole calendar for the day. It's simple, useful, and has become part of how they manage their workflow."



"Framery's solution is solid—it's easy to implement, and easy to use. From an IT perspective, it doesn't get much smoother than this."

And as Inderes looks ahead, Framery smart office solutions can be extended to their Stockholm office—bringing the same clarity, structure, and smart functionality to a new location, without starting from scratch.

Resulting in a workplace experience that scales with the business—and works better for everyone.

A 360 approach to sustainability

For Framery, sustainability serves as a foundational principle. "Sustainability is core to our business," states Tomi Nokilainen, Head of R&D. "We view it as fundamental to our long-term success and deeply integrated into our operations and values."

As a UN Global Compact member, the company has big environmental targets. It plans to cut Scope 1 & 2 emissions by 50% by 2030, following rigorous SBTi 1.5°C guidelines. Framery is also on track to cut product-related emissions in half by 2028, with a 19% reduction achieved this year. This commitment is exemplified at their Tampere, Finland factory, which operates exclusively on 100% zero-emission electricity. Furthermore, with 80% of the supply chain concentrated within the Nordic and Baltic regions, the company ensures access to sustainable resources while upholding robust ethical and environmental standards.

Framery is working to combat the "fast furniture" problem, where about 80% of office furniture ends up in landfills. Nokilainen says their goal is to offer a sustainable alternative with pods built to last and easy to refurbish, which reduces waste. In 2024, they achieved an impressive 95.7% material efficiency by cutting waste in production. Reducing new materials is also a priority.

They achieve this by making lighter pods (new smart pod models are 23% lighter thanks to a patented design) and using recycled materials in the pod structure and interior. The company is also exploring new materials not yet common in workplace products and plans to be the first to use fossil-free steel once it's available.

The sustainability focus for these pods extends well beyond their initial purchase. "We believe true sustainability lies in maximizing a product's usable life," says Nokilainen. Recognizing this, the pods are engineered for exceptional durability, featuring modular components designed for easy replacement, facilitating decades of use and straightforward recycling at the end of their lifecycle. Framery's Smart Office Solutions provide office managers with data-driven tools aimed at optimizing pod utilization and overall office space efficiency, thereby promoting what Nokilainen refers to as the ideal scenario: "the most efficient pod is the one used to its fullest extent."

Services such as Framery Subscribed further enhance the product lifespans. Under this leasing model, returned pods undergo refurbishment and repair for a new lifecycle with a different customer. Partnerships with third-party resellers also contribute to giving pre-owned pods a second life. "These initiatives are key steps in embracing our circular economy principles," Nokilainen notes.

Beyond innovation and durability, the company places a strong emphasis on health and safety standards. "As industry leaders, we don't want to just set the benchmark for innovation and durability but also for health and safety," Nokilainen states. The pods are manufactured without toxic materials, ensuring high indoor air quality, a feature certified by GREENGUARD. This commitment is supported by rigorous fire, seismic, and general product safety testing, guaranteeing a safe and healthy environment for users.

30%*

lower carbon footprint of Framery pods on average, compared to fixed constructions, over a 20-year lifetime.

Based on study findings, Framery pods can be used to reduce the environmental impact of office construction and renovation.

The study is demonstrative, and situations may vary depending on the location and the company. However, the calculations can be applied to alternative scenarios as well.

From the climate point of view, it is clear that the pods provide the greatest value in terms of carbon handprint when their flexibility and ease of relocation is fully utilized.

*on average, according to the study conducted by UseLess Company.



Read more from our Sustainability report



Fossil free steel

At Framery, sustainability is critical to our innovation and strategy work. On a mission to decarbonize the office, Framery commits to building future smart pods using SSAB's fossil-free steel.

- 01 Material swatches
- 02 The first delivery of fossil free steel
- 03 Interior material

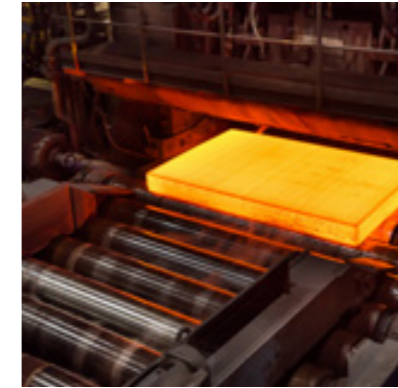

02



01



03

Bringing fossil-free steel products to the office and workplace sector is not only a huge milestone for Framery but also for the industry; emissions from building material and construction account for 11% of all emissions and office furniture is the biggest contributor to furniture waste globally.

Framery CEO Samu Hällfors sees this as an important step towards sustainable office development, "We see this collaboration not as a choice but a necessity. From 2026, as soon as the material/steel becomes available, we will start bringing fossil-free steel pods to offices worldwide."

For thousands of years, steel has been made using coal to remove oxygen from iron ore, emitting vast amounts of CO₂ in the process. But now, SSAB is set to revolutionize the industry with HYBRIT® technology in their pilot plant, using hydrogen instead of coal in the ore reduction process, and emitting water instead of CO₂.

SSAB is revolutionising steelmaking with virtually zero fossil carbon emissions, paving the way for a greener future. Given Framery's ambitions to create more sustainable office furniture, SSAB was the natural partner.

Framery's Smart Pods are already on average 30% less emission intensive than building a meeting room over

a lifecycle, are 100% recyclable, and more durable; using fossil-free steel is the brand's next big step towards building the world's most sustainable pod.

Framery's Head of Supply Chain Hannu Seppä shares, "Our objective is to reduce CO₂ emissions by 50% per pod by 2028 compared to the 2023 level, while increasing the number of deliveries. This can only be achieved by relentlessly innovating and not waiting for others to try out new technologies and methods."

"We are excited to collaborate with Framery to drive sustainability in the workplace," says Lotta Ruottinen, Sales Director at SSAB Europe. "Fossil-free steel presents a compelling opportunity to reduce carbon emissions and minimise environmental impact. Together with Framery, we are shaping a more sustainable future for the workplace."

Download our 2023 Sustainability Report from the link below to learn about our global commitments and initiatives for a healthier planet, and the actions we are taking to reach them.

Framery products



Framery is the pioneer of soundproof office pods and workspaces. Every detail of every product is carefully considered and perfected to ensure people can focus on what really matters.

SET YOUR OFFICE UP FOR SUCCESS

Workplace technology that changes how your office operates

The smart office solutions is a collection of physical and digital services that streamlines workdays, elevates productivity and enhances the entire workplace experience. These new tools allow you to access real-time occupancy data, facilitate data-driven decisions, reserve meeting spaces on the go, and enhance focus, privacy, and productivity throughout the office.

Framery smart office solutions / Set your office up for success

Framery's smart solutions boost productivity and flexibility with intuitive workplace tech. Enhance the employee experience with seamless room booking, access workplace-wide insights, and make data-driven decisions. Book any space instantly—on-site or on the go.

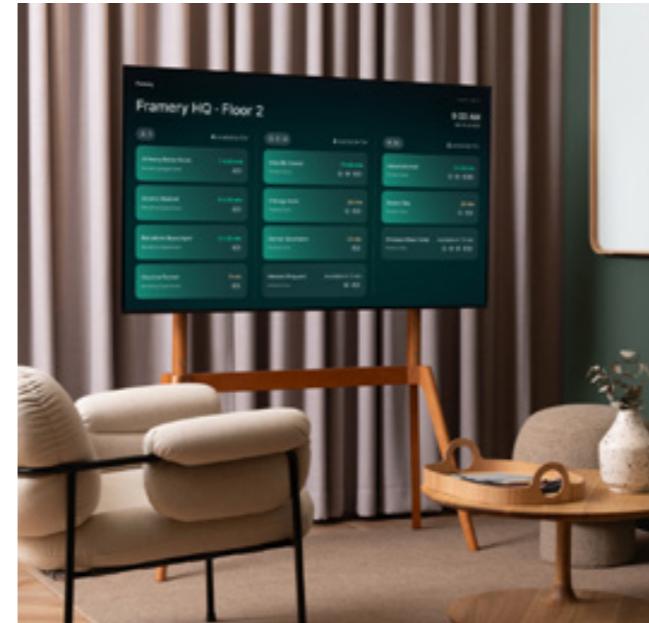

NEW

Framery Space Overview™

ROOM BOOKING SOLUTIONS Framery Space Overview shows real-time space availability across nearby workspaces. Employees can instantly view which spaces are free, along with their location and capacity, and book them directly.

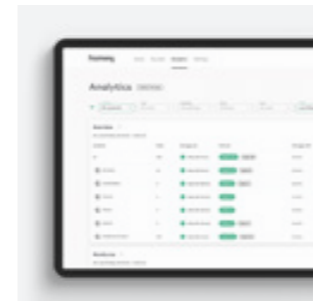

Framery Connect™

WORKPLACE MANAGEMENT
A smart platform for workplace management.



Framery Connect Sensor™

WORKPLACE MANAGEMENT
Collect usage data from any space.

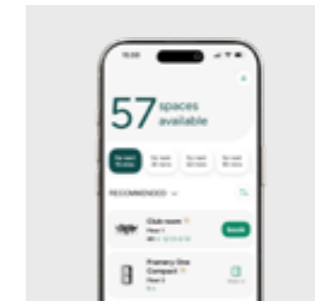

Framery App™

ROOM BOOKING SOLUTIONS
Find and book spaces in seconds.

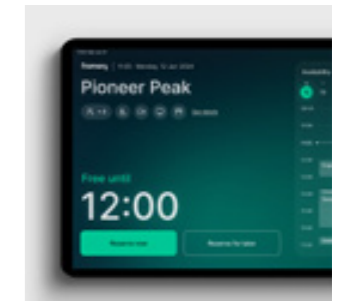

Framery Room Display™

ROOM BOOKING SOLUTIONS
See availability and book any room with ease.

Unparalleled support

Get instant support from a Framery specialist for any issues that may arise with your smart pods or other products.

Automatic updates

Instantly receive software updates through your smart pod's 4G connection to enable the future developments.

Privacy assured

No identifiable user data is collected—only workspace occupancy information is tracked.

FRAMERY PLUS—EVERYTHING YOU NEED FOR A SUCCESSFUL WORKPLACE

Unlock all the tools and features your workplace needs to thrive with our subscription based Framery Plus™—new smart pod customers receive a complimentary 1-year subscription.

Read more



Framery One Compact



Framery One Compact is a smart, spacious, one-person phone booth designed for phone and video calls. This state-of-the-art soundproof office pod is packed with technology, featuring world-class sound insulation, echo-free acoustics, adaptive ventilation and automated lighting—so you can focus on your calls and connect online with people anywhere.



Workdays that flow with ease

Framery One Compact has been purposefully designed to make your workdays flow better. Find and book the pod in advance or on-the-fly from the Framery app. Or step inside and the pod automatically creates a reservation for you. Extend your reservation directly from the pod's touchscreen, or adjust your booking through the app.



Privacy you can trust

The fine-tuned acoustic structure provides A-Class soundproofing that allows the pod to be placed next to workstations without causing noise distractions to the user or to those outside of the pod. And echo-free interior acoustics make the pod a private, comfortable place for work and video calls.



Airflow that keeps you fresh

The pod recognizes when it's occupied, senses the temperature and humidity of the surroundings, and triggers adjustments to the airflow accordingly. Enhanced ventilation fully refreshes the air every minute, and ventilation can be easily adjusted through the pod's touchscreen.



Lighting that makes you feel good

Automated dual-lighting sources adapt to your needs, with preset lighting options to choose between work or video modes. Video-optimized lighting helps you shine on video calls. Adjustments can be made quickly and easily through the touchscreen display.



1. A-CLASS SOUNDPROOFING

Guaranteed privacy with fine-tuned Class A speech level reduction of 30dB—and the industry's top ISO 23351-1 rating for office phone booths.

2. FRAMERY OFFICE SOUND MASKING SYSTEM™

The embedded system is based on patent-pending technology that reduces noise distractions and protects speech privacy in office environments by adding a subtle, unobtrusive background sound outside of the pod. This ambient background noise, similar to air flow, is specifically designed to blend in with the office's noise atmosphere—making sounds less intelligible and therefore less distracting.

3. ADAPTIVE VENTILATION

Proprietary design enables unparalleled ventilation with maximum airflow of 36 l/s—surpassing industry standards around the world.

4. TEMPERATURE & HUMIDITY SENSORS

Sensors inside the pod recognize the temperature and humidity of the office environment, and automatically optimize the airflow accordingly.

5. AUTOMATIC LIGHTING MODES

Dual adjustable 4000K LED light sources allow you to seamlessly switch between video or work modes—or make manual adjustments for personalized illumination.

6. 8-INCH TOUCHSCREEN

An intuitive, 8-inch high-resolution touchscreen makes it easy to control pod settings, adjust lighting and airflow, and extend calendar reservations effortlessly.

7. AUTOMATIC UPGRADES

A built-in 4G connection enables automatic over-the-air software updates—initiated instantly and silently in the background.

8. MMWAVE RADAR PRESENCE DETECTION

Millimeter-wave radar sensors immediately detect when someone enters or leaves the pod, allowing lighting and ventilation to adjust accordingly. Occupancy data is gathered and displayed through Framery Connect to provide information about when the pod is being used the most.

9. FRAMERY CONNECT™

Gain insights from occupancy data, initiate advanced bookability functionalities, and connect your Framery One Compact to the entire office to get valuable usage data needed to improve the layout and efficiency of your workplace.

10. BOOKABLE PODS

Make your smart pod bookable like any meeting room. The pod's touchscreen will show reservations and you can manage them on the spot.

Framery One Compact / Design details

Framery One Compact feels spacious inside while taking a minimal amount of floor space. This phone booth is built to last with a lightweight structure and efficient use of materials without compromising performance or quality. The minimalistic design approach uses carefully curated materials, making it a sustainable choice.

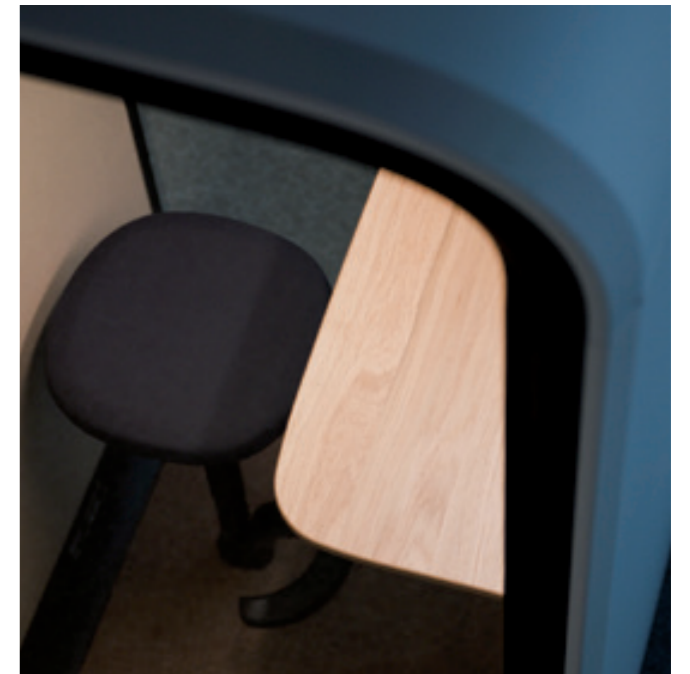

Framery One Compact's powder-coated exterior panels are made from deepdrawn steel. Matt black structures made from aluminum create the framing, and sound-control laminated glass finish the structural support.

The pod chassis is made of a light steel structure. Replaceable interior paneling are made from PET sound-absorbing material. Anti-static, stain resistant low-loop pile carpeting covers the flooring.



The top-mounted occupancy lights show at a glance whether the pod is available or already taken.



The custom-designed table comfortably fits a laptop, and a built-in power outlet and coat hook are provided for all your office accessories.



The height-adjustable seat and built-in footrest prioritize comfortable and ergonomic working positions.

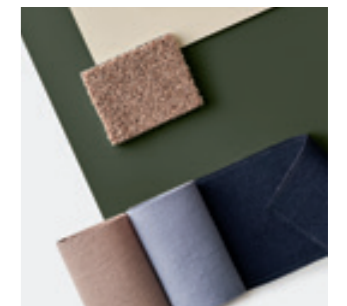

Customize your pod to fit your workplace with over 3000 combinations of colors, fabrics, and high-quality materials to choose from.

Framery One

Framery One is a smart, spacious, one-person workstation designed for video calls and focus work. Contemporary design and advanced technology characterize every detail of this comfortable and versatile workspace. This soundproof office pod features world-class sound insulation, industry-leading ventilation, and echo-free acoustics so you can focus on your work and connect online with people anywhere.



Workdays that flow with ease

Framery One has been purposefully designed to make your workdays flow easier. Automatically reserve a vacant pod by stepping inside, or book it in advance from the Framery app. Extend your reservation directly from the pod's touchscreen, or adjust your booking through the app.



Privacy you can trust

A-Class soundproofing assures that Framery pods can be placed next to workstations without causing noise distractions to the person in the pod or to the people outside. And echo-free interior acoustics make Framery One a private, comfortable place for work and video calls.



Airflow that keeps you fresh

Stay fresh and focused with efficient airflow. Enhanced ventilation fully refreshes the air every minute. The ventilation can be easily adjusted to the user's preferences through the pod's touchscreen display with a single touch.



Lighting that makes you feel good

Automated dual-lighting sources adapt to your needs, with preset lighting options to choose between work or video modes. Video-optimized lighting helps you shine on video calls. Adjustments can be made quickly and easily through the touchscreen display.



1. A-CLASS SOUNDPROOFING

Guaranteed privacy with an industry leading Class A speech level reduction of 30dB and one of the industry's top ISO 23351-1 ratings for office phone booths.

2. ADJUSTABLE VENTILATION

Proprietary design enables unparalleled ventilation with maximum airflow of 29 l/s—surpassing industry standards around the world.

3. OPTIMIZED LIGHTING

Dual adjustable 4000K LED light sources allow you to seamlessly switch between video or work modes—or make manual adjustments for personalized illumination

4. AUTOMATED WALK-IN RESERVATIONS

Step inside the pod to create an automatic walk-in reservation—or easily find and book Framery One through the Framery app. Adjust your booking from the mobile application, or directly from inside the pod.

5. BUILT-IN 4G CONNECTION

Framery smart pods come with built-in 4G connection enabling over the air software updates and keeping your pods connected to your calendar.

6. INTUITIVE UI

A high-resolution touchscreen makes it easy to control pod settings,

adjust lighting and airflow, and manage calendar reservations.

7. AUTOMATIC UPDATES

A built-in 4G connection enables automatic over-the-air software updates—initiated instantly and silently in the background.

8. OCCUPANCY INDICATION

The side-mounted occupancy lights show at a glance whether the pod is free or already in use. The pod's usage data is gathered and visualized in Framery Connect™ to help ensure you have the right number pods, and that they are placed correctly in your office.

9. FRAMERY CONNECT™

Gain insights from occupancy data, initiate advanced bookability functionalities, and connect your Framery One to the entire office to get valuable usage data needed to improve the layout and efficiency of your workplace.

10. BOOKABLE PODS

Make your smart pod bookable like any meeting room. The pod's touchscreen will show reservations and you can manage them on the spot.

Framery One / Design details

Contemporary design and advanced technology characterize every detail of this comfortable and stylish soundproof pod that is built sustainably and engineered to last. Framery One is available in three distinct layouts, each designed to support a different way of working. Whether you need ergonomic adjustability, relaxed comfort, or open flexibility, there's a configuration to match your workday rhythm.



Ideal for tasks that require extended focus, Framery One is available with an electric work desk, a built-in height-adjustable stool, and dual footrests to support ergonomic working positions, and allow users to fine-tune their setup for comfort and concentration.



For more relaxed experience, an optional built-in sofa and curved desk create a comfortable, informal workspace that is well-suited for virtual meetings, solo work, or quiet moments between tasks. The table can be upgraded to an electric work desk.



The exterior occupancy lights show at a glance whether the pod is available or already taken.

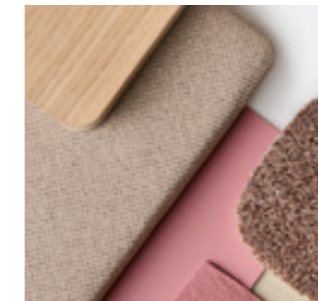

Customize your pod to fit your workplace with over 3000 combinations of colors, fabrics, and high-quality materials to choose from.



An optional monitor wall mount lets you add a full-sized display for additional flexibility.

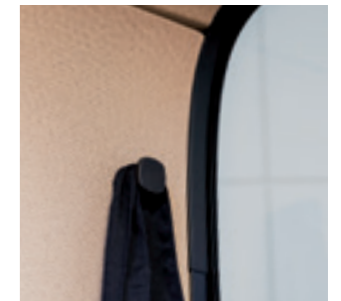

Convenient outlets and a coat hook are provided to accommodate all your office accessories.

Framery Four



Framery Four is a smart office meeting pod for up to 4 people. This multifunctional soundproof meeting space is engineered for face-to-face meetings and hybrid work from the office. Fine-tuned acoustics and soundproofing provides privacy for discussions and virtual calls. Framery Four's adaptive ventilation and automated lighting let you focus on what really matters and have a successful workday.



Workdays that flow with ease

Framery Four has been purposefully designed to make your workdays flow better. Find and book the pod in advance or on-the-fly from the Framery app. Or step inside and the pod automatically creates a reservation for you. Extend your reservation directly from the pod's touchscreen, or adjust your booking through the app.



Privacy you can trust

The fine-tuned acoustic structure provides A-Class soundproofing that allows the pod to be placed next to workstations without causing noise distractions to the user or to those outside of the pod. And echo-free interior acoustics make the pod a private, comfortable place for work and video calls.



Airflow that keeps you fresh

The pod recognizes when it's occupied, senses the temperature and humidity of the surroundings, and triggers adjustments to the airflow accordingly. Enhanced ventilation fully refreshes the air every minute, and ventilation can be easily adjusted through the pod's touchscreen.



Lighting that makes you feel good

Multiple automated light sources adapt to your needs, with preset lighting options to choose between work or video modes. Video-optimized lighting helps you shine on video calls. Adjustments can be made quickly and easily through the touchscreen display.



Framery Four / Design details

Framery Four easily fits any office thanks to its efficient size and sleek design. The interior is luxurious in space, easily fitting two comfortable sofas and lots of table space. The low threshold enables easy access. Choose from a variety of colors and interior options to make the pod fit your environment seamlessly. Framery Four is designed sustainable and built to last.

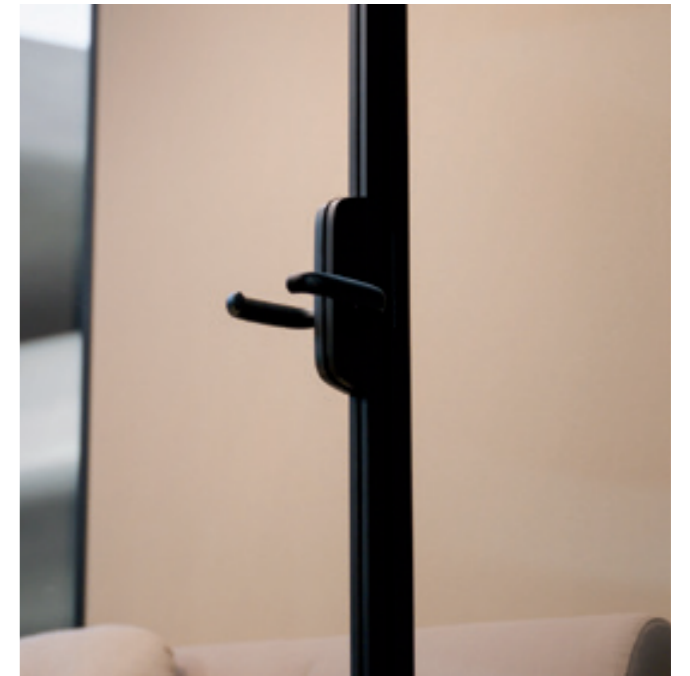

1. A-CLASS SOUNDPROOFING

Guaranteed privacy with fine-tuned Class A speech level reduction of 30dB—and the industry's top ISO 23351-1 rating for office phone booths.

2. FRAMERY OFFICE SOUND MASKING SYSTEM™

The embedded system is based on patent-pending technology that reduces noise distractions and protects speech privacy in office environments by adding a subtle, unobtrusive background sound outside of the pod. This ambient background noise, similar to air flow, is specifically designed to blend in with the office's noise atmosphere—making sounds less intelligible and therefore less distracting.

3. ADAPTIVE VENTILATION

Proprietary design enables unparalleled ventilation with maximum airflow of 100 l/s—surpassing industry standards around the world.

4. TEMPERATURE & HUMIDITY SENSORS
Sensors inside the pod recognize the temperature and humidity of the office environment, and automatically optimize the airflow accordingly.

5. AUTOMATIC LIGHTING MODES

Multiple adjustable 4000K LED light sources allow you to seamlessly switch between video or work modes—or make manual adjustments for personalized illumination.

6. 8-INCH TOUCHSCREEN

An intuitive, 8-inch high-resolution touchscreen makes it easy to control pod settings, adjust lighting and airflow, and extend calendar reservations effortlessly.

7. AUTOMATIC UPGRADES

A built-in 4G connection enables automatic over-the-air software updates—initiated instantly and silently in the background.

8. MMWAVE RADAR PRESENCE DETECTION

Millimeter-wave radar sensors immediately detect when someone enters or leaves the pod, allowing lighting and ventilation to adjust accordingly.

Occupancy data is gathered and displayed through Framery Connect to provide information about when the pod is being used the most.

9. FRAMERY CONNECT™

Gain insights from occupancy data, initiate advanced bookability functionalities, and connect your Framery Four to the entire office to get valuable usage data needed to improve the layout and efficiency of your workplace.

10. BOOKABLE PODS

Make your smart pod bookable like any meeting room. The pod's touchscreen will show reservations and you can manage them on the spot.

Framery Four's powder-coated exterior panels are made from deepdrawn and bended steel. Matt black structures made from aluminum create the framing, and sound-control laminated glass finish the structural support.

The pod chassis is made of a light steel structure. Replaceable interior paneling are made from PET sound-absorbing material. Anti-static, stain resistant low-loop pile carpeting covers the flooring.



The exterior occupancy lights show at a glance whether the pod is available or already taken.



The custom-designed table comfortably accommodates laptops, and built-in power outlets and optional coat hooks support all your office accessories. An optional adjustable monitor arm can be inserted directly into the table leg to support a 27" screen.

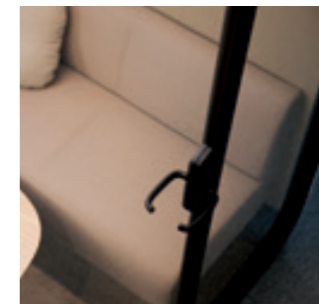

The sofas of Framery Four are specially designed to fit four people comfortably. Custom cushions are available for additional comfort and support.



An optional gather zone outside of Framery Four creates an additional meeting area, featuring a convenient add-on rail where a whiteboard or additional display can be attached.

Framery Four Accessible

Framery Four Accessible is a fully accessible smart office meeting pod. This soundproof meeting space is ADA compliant—featuring folding furniture, a low threshold, and a T-shaped turning space. Packed with the same advanced technology and functionality as the entire line of Framery smart pods, Framery Four Accessible is a comfortable, adaptive, and multifunctional space for meetings and hybrid work.

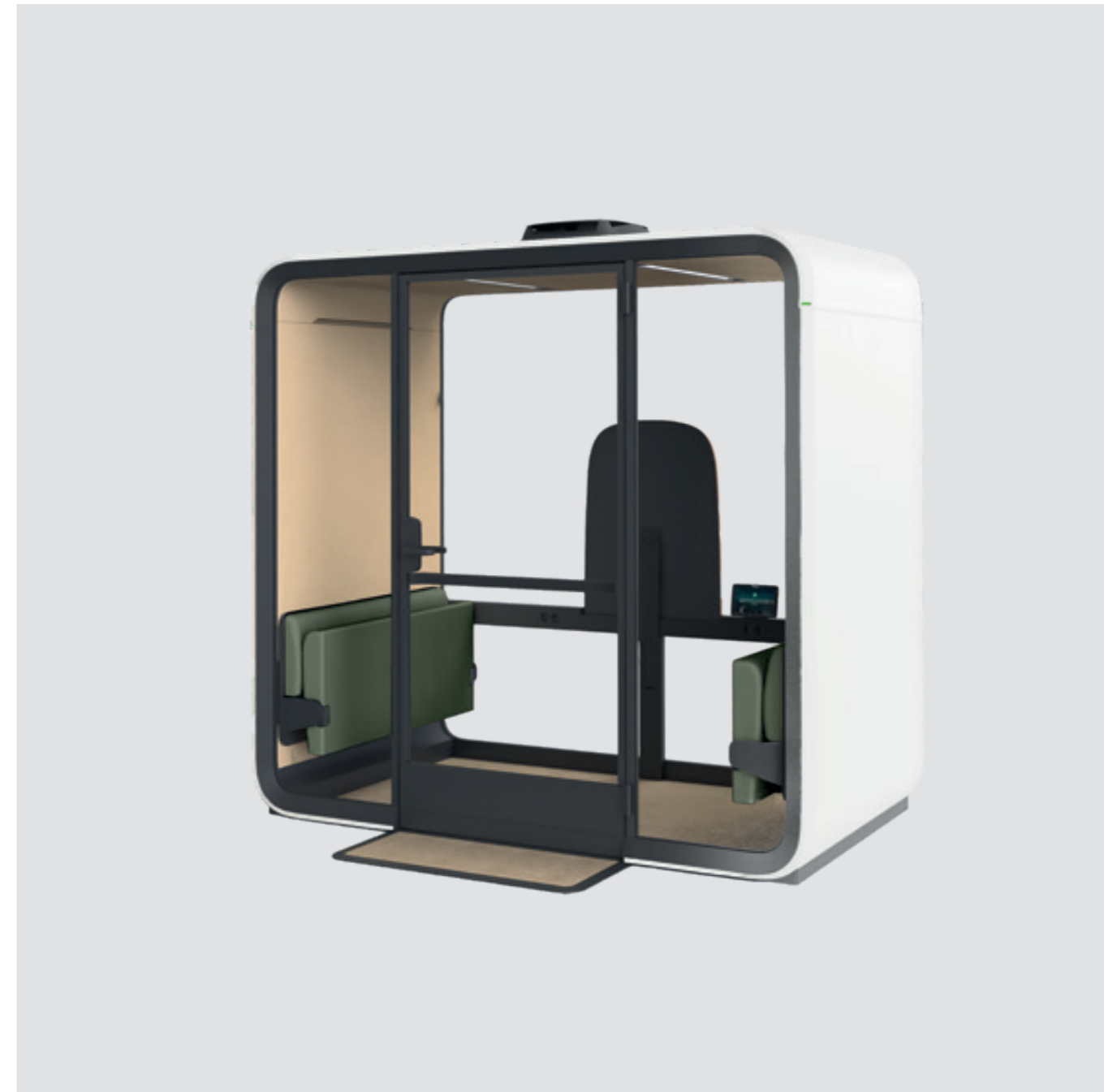

Workdays that flow with ease

Framery Four Accessible has been purposefully designed to make your workdays flow better. Find and book the pod in advance or on-the-fly from the Framery app. Or step inside and the pod automatically creates a reservation for you. Extend your reservation directly from the pod's touchscreen, or adjust your booking through the Framery app.



Privacy you can trust

The fine-tuned acoustic structure provides A-Class soundproofing that allows the pod to be placed next to workstations without causing noise distractions to the user or to those outside of the pod. And echo-free interior acoustics make the pod a private, comfortable place for work and video calls.



Airflow that keeps you fresh

The pod recognizes when it's occupied, senses the temperature and humidity of the surroundings, and triggers adjustments to the airflow accordingly. Enhanced ventilation fully refreshes the air every minute, and ventilation can be easily adjusted through the pod's touchscreen display.



Lighting that makes you feel good

Multiple automated light sources adapt to your needs, with preset lighting options to choose between work or video modes. Video-optimized lighting helps you shine on video calls. Adjustments can be made quickly and easily through the touchscreen display.



1. A-CLASS SOUNDPROOFING
Guaranteed privacy with fine-tuned Class A speech level reduction of 30dB—and the industry’s top ISO 23351-1 rating for office meeting pods.

2. FRAMERY OFFICE SOUND MASKING SYSTEM™

The embedded system is based on patent-pending technology that reduces noise distractions and protects speech privacy in office environments by adding a subtle, unobtrusive background sound outside of the pod. This ambient background noise, similar to air flow, is specifically designed to blend in with the office’s noise atmosphere—making sounds less intelligible and therefore less distracting.

3. ADAPTIVE VENTILATION
Proprietary design enables unparalleled ventilation with maximum airflow of 100 l/s—surpassing industry standards around the world.

4. TEMPERATURE & HUMIDITY SENSORS

Sensors inside the pod recognize the temperature and humidity of the office environment, and automatically optimize the airflow accordingly

5. AUTOMATIC LIGHTING MODES

Multiple adjustable 4000K LED light sources allow you to seamlessly switch between video or work modes—or make manual adjustments for personalized illumination.

6. 8-INCH TOUCHSCREEN
An intuitive, 8-inch high-resolution touchscreen makes it easy to control pod settings, adjust lighting and airflow, and extend calendar reservations effortlessly.

7. AUTOMATIC UPGRADES
A built-in 4G connection enables automatic over-the-air software updates—initiated instantly and silently in the background.

8. MMWAVE RADAR PRESENCE DETECTION
Millimeter-wave radar sensors immediately detect when someone enters or leaves the pod, allowing lighting and ventilation to adjust accordingly.

Occupancy data is gathered and displayed through Framery Connect to provide information about when the pod is being used the most.

9. FRAMERY CONNECT™
Gain insights from occupancy data, initiate advanced bookability functionalities, and connect your Framery Four to the entire office to get valuable usage data needed to improve the layout and efficiency of your workplace.

10. BOOKABLE PODS
Make your smart pod bookable like any meeting room. The pod’s touchscreen will show reservations and you can manage them on the spot.

Framery Four Accessible / Design details

Designed according to ADA standards, Framery Four Accessible combines the sophisticated engineering of Framery smart pods with accommodating features to improve usability even further. A door opening ratio of 180°, a structured black metal pull bar, and an easy-to-reach accessory rail make Framery Four Accessible an equitable private space for every user.



Framery Four Accessible features a face-to-face layout designed to support better meetings. The meeting pod is furnished with a sturdy table and comfortable twin sofas that easily fold up to enable access to the pod and create a T-shaped turning space.



Designed for modern work, Framery Four Accessible utilizes advanced technology to create the perfect atmosphere for any meeting. With the industry’s most powerful adaptive ventilation system, video-optimized lighting, and two preset lighting modes for video or focused work.

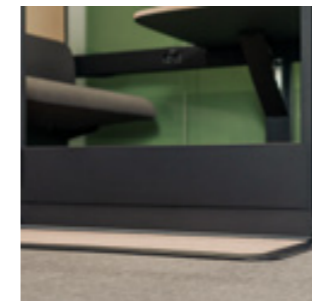

The low threshold (1.27 cm / 0.5 in) and the external platform makes it easy to access the pod with a wheelchair.

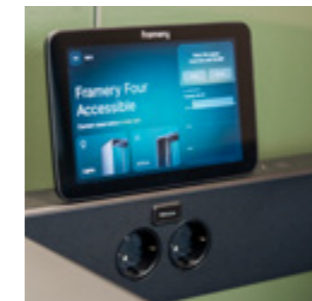

Outlets, charge ports, and an 8-inch touchscreen are embedded in a convenient accessory bar and placed within operative height.

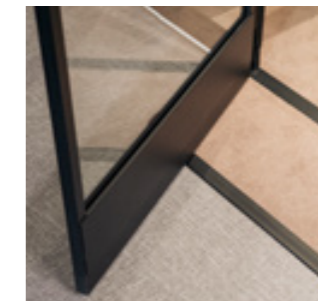

The door has a door opening ratio of 180° and sturdy black metal pull bar for opening and closing the door effortlessly.



The folding table serves as a functional work desk. The folding sofas have been designed without compromising the seating comfort.

Framery Six



Framery Six is a smart meeting room for up to 6 people. This multifunctional soundproof meeting space is tailored for collaborative teamwork and enhanced for face-to-face and hybrid brainstorming sessions. With finely-tuned acoustics and top-notch soundproofing, it ensures privacy during discussions and virtual meetings. Framery Six's adaptive ventilation and automated lighting ensure your team can focus on what really matters and have a successful workday.



Workdays that flow with ease

Framery Six has been purposefully designed to make your workdays flow better. Find and book the pod in advance or on-the-fly from the Framery app. Or step inside and the pod automatically creates a reservation for you. Extend your reservation directly from the pod's touchscreen, or adjust your booking through the app.



Privacy you can trust

The fine-tuned acoustic structure provides A-Class soundproofing that allows the pod to be placed next to workstations without causing noise distractions to the user or to those outside of the pod. And echo-free interior acoustics make the pod a private, comfortable place for work and video calls.



Airflow that keeps you fresh

The pod recognizes when it's occupied, senses the temperature and humidity of the surroundings, and triggers adjustments to the airflow accordingly. Enhanced ventilation fully refreshes the air every minute, and ventilation can be easily adjusted through the pod's touchscreen.



Lighting that makes you feel good

Multiple automated light sources adapt to your needs, with preset lighting options to choose between work or video modes. Video-optimized lighting helps you shine on video calls. Adjustments can be made quickly and easily through the touchscreen display.



1. A-CLASS SOUNDPROOFING

Guaranteed privacy with fine-tuned Class A speech level reduction of 30dB—and the industry's top ISO 23351-1 rating for office phone booths.

2. FRAMERY OFFICE SOUND MASKING SYSTEM™

The embedded system is based on patent-pending technology that reduces noise distractions and protects speech privacy in office environments by adding a subtle, unobtrusive background sound outside of the pod. This ambient background noise, similar to air flow, is specifically designed to blend in with the office's noise atmosphere—making sounds less intelligible and therefore less distracting.

3. ADAPTIVE VENTILATION

Proprietary design enables unparalleled ventilation with maximum airflow of 187 l/s—surpassing industry standards around the world.

4. TEMPERATURE & HUMIDITY SENSORS

Sensors inside the pod recognize the temperature and humidity of the office environment, and automatically optimize the airflow accordingly.

5. AUTOMATIC LIGHTING MODES

Multiple adjustable 4000K LED light sources allow you to seamlessly switch between video or work modes—or make manual adjustments for personalized illumination.

6. 8-INCH TOUCHSCREEN

An intuitive, 8-inch high-resolution touchscreen makes it easy to control pod settings, adjust lighting and airflow, and extend calendar reservations effortlessly.

7. AUTOMATIC UPGRADES

A built-in 4G connection enables automatic over-the-air software updates—initiated instantly and silently in the background.

8. MMWAVE RADAR PRESENCE DETECTION

Millimeter-wave radar sensors immediately detect when someone enters or leaves the pod, allowing lighting and ventilation to adjust accordingly.

Occupancy data is gathered and displayed through Framery Connect to provide information about when the pod is being used the most.

9. FRAMERY CONNECT™

Gain insights from occupancy data, initiate advanced bookability functionalities, and connect your Framery Six to the entire office to get valuable usage data needed to improve the layout and efficiency of your workplace.

10. BOOKABLE PODS

Make your smart pod bookable like any meeting room. The pod's touchscreen will show reservations and you can manage them on the spot.

Framery Six / Design details

Framery Six combines the best features of a larger meeting room in a convenient, modular package. The luxurious and spacious interior comes equipped with a proper-sized meeting table that can be complemented with your own choice of seats. The pod's low threshold enables easy access, and the minimalistic design approach uses carefully curated materials, making it a sustainable choice.

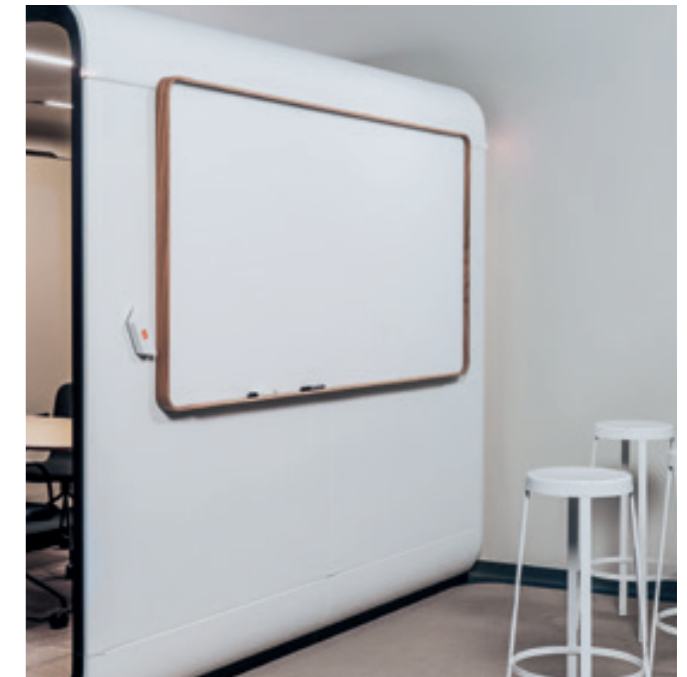

Framery Six is designed to bring teams together—whether you're meeting face-to-face or collaborating online. The space is tailored for collaborative teamwork, and enhanced for face-to-face and hybrid brainstorming sessions.

The optional gather zone outside of Framery Six creates an additional meeting area, featuring matching carpet and a convenient add-on rail where a whiteboard or additional display can be attached. This effectively doubles the amount of working space that Framery Six can offer.



The exterior occupancy lights show at a glance whether the pod is available or already taken.

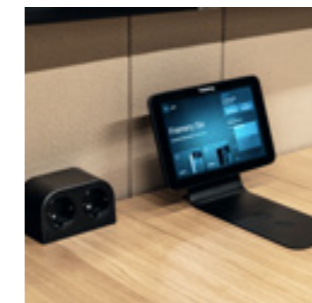

The custom-designed table comfortably accommodates an entire team, and built-in power outlets and optional coat hooks support all your office accessories.



An optional interior whiteboard can be provided to make it even easier to collaborate participants during meetings.

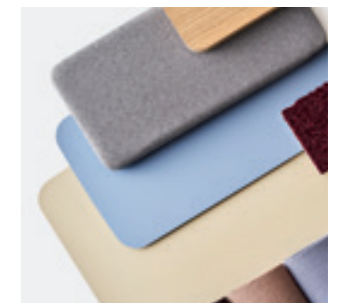

Customize your pod to fit your workplace with hundreds of combinations of colors, fabrics, and high-quality materials to choose from.

Materials and sustainability



At Framery, sustainability isn't just a goal—it's the cornerstone of our new product line. Designed with durability measured in decades, lightweight structures, and the use of truly recyclable materials, our pods set the standard for eco-conscious design.

Framery smart pods / Environmental data sheet

Made with waste – not to waste.

The “fast furniture” trend means 80% of office furniture ends up in landfills. We wanted to create a pod that’s part of the solution, not the problem. That’s why we build our pods optimizing the use of recycled materials, and more importantly, design them to last decades. Plus, our smart office solutions help maximize space usage.

Framery measures its impact holistically and there are three primary focus areas: Climate and Environment, People and Society, and Fair Business. We annually publish the sustainability report and update our Environmental Product Declarations (EPDs), which are based on third-party reports and validation. Additionally, Framery has a positive net impact ratio meaning that the company creates more value compared to the resources it uses.

UN Global Compact & Science

Based Targets initiative

We participate in the UN Global Compact as well as the Science Based Targets initiative and have set emission-reduction targets aligned with the goal of limiting global warming to 1.5°C compared to pre-industrial levels. We have also set a target to reduce our emissions per pod by more than 50% by 2028 compared to 2023.

Material and environmental efficiency

We aim to reduce our reliance on virgin materials by optimizing recycled whenever possible, while balancing that goal with

material availability and ensuring our pods remain durable and high-quality.

Our smart pods feature:

- interior carpet with 20% recycled content
- interior panels with 60-70% recycled material
- sound-absorbing panels with 50-60% recycled content
- glass typically with 20-33% recycled content
- steel and aluminum with 0-30% recycled content (due to global demand)

The material efficiency rate describes the volume of waste in relation to the input materials. In 2024, our material efficiency reached 95.7% at our factory. More than half of the waste generated is bio-based waste that is directed to incineration with energy recovery. We don’t use any water in our manufacturing processes.

Sustainability throughout the pod's lifecycle

Leveraging their smart features and connectivity, even after manufacturing, our smart pods can receive over-the-air (OTA) updates that further improve their sustainability. We have already released an OTA update that automatically reduced the lifetime electricity usage by approximately 30% which contributed to a lower carbon footprint for all manufactured and connected smart pods globally—no input was required from the smart pod owners.

The most efficient pod is the one used to its fullest extent and our smart office solutions help customers to maximize pod utilization. From ensuring pods are easy to book and comfortable to use, to optimizing their occupancy, our range of digital products helps ensure a long, productive life for our smart pods.

The majority of the pods’ components are modular, refurbishable and easily replaceable to ensure decades of use. Because the smart pods are so durable and easy to relocate, there is also a second-hand market for our pods.

Certificates and studies available:

- Life Cycle Assessment (LCA)
- Environmental Product Declarations (EPDs)
- Health Product Declarations (HPD)
- Declare labels
- Möbelfakta
- UL GREENGUARD Gold
- Contribution to green building certifications such as LEED certifications, BREEAM, SKA and WELL



Framery has been awarded with a Silver Medal sustainability rating from Ecovadis sustainability – placing us among the top 8% percent of companies assessed in the past year.



Framery holds the Certified Autism Resource (CAR) designation, earned after an IBCCES expert board certified its product aligns with competency areas to meet the needs of individuals with autism.



Find the sustainability report and the smart pods’ EPDs by scanning the QR code or go to framery.com.

Framery smart pods / Colors and finishes

EXTERIORS

- White (Standard) RAL 9016 Ultramatt
- Black (Standard) RAL 9005 Ultramatt
- Gray (Standard) S 7500–N Ultramatt
- Navy S 7020–R90B Ultramatt
- Sand S 2010–Y20R Ultramatt
- Powder Blue 3421-R86B Ultramatt
- Winter Moss S 7010-G10Y Ultramatt
- Blush 2728-R01B Ultramatt

INTERIORS

- Pure Gray (Standard) Tonal #60123 Gabriel
- Arctic Blue Tonal #66185 Gabriel
- Sand Tonal #61180 Gabriel
- Rouge Tonal #64210 Gabriel

CARPETS

- Light Gray (Standard) Fletco carpets
- Dark Blue Fletco carpets
- Champagne Fletco carpets
- Grape Fletco carpets

TABLE TOPS

- White (Standard) White laminate
- Black Black Laminate with anti-fingerprint surface
- Oak Veneer

CUSHIONS FOR FRAMERY FOUR

- Charcoal Capture #5501 Gabriel
- Latte Capture #3301 Gabriel

SEATING FABRICS

- Graphite (Standard) Select #60051 Gabriel
- Dark Blue Select #66144 Gabriel
- Grape Select #61190 Gabriel
- Rose Select #65117 Gabriel
- Powder Blue Select #67098 Gabriel
- Beige Select #61184 Gabriel
- Green Select #68209 Gabriel
- Mustard Select #62098 Gabriel

MATERIALS AND FINISHES



EXTERIOR PANELS made from steel feature a powder-coated matt finish. The lightweight panels are joined together seamlessly, with elegant curves that create a timeless design.



INTERIOR PANELS made from high-quality and recycled polyester have a vibrant and dynamic look thanks to the mix of the two-colored fabric.

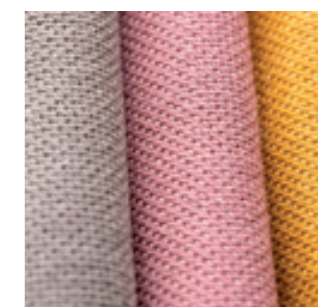

SEATING MATERIALS are a blend of superior New Zealand wool and polyamid that form a soft and rich texture. The extremely durable fabrics are both dirt and water repellent.

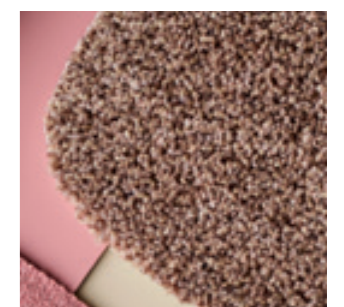

CARPET FLOORING is anti-static, stain resistant, and durable, giving the pod an overall soft look and finish.

Design your own on our website



Technical specifications

FRAMERY ONE COMPACT

The smart and soundproof office phone booth

FRAMERY ONE

The smart and soundproof office pod

FRAMERY FOUR

The smart and soundproof office meeting pod

FRAMERY FOUR ACCESSIBLE

The smart and ADA compliant soundproof meeting pod

FRAMERY SIX

The smart and soundproof office meeting room

Framery One Compact / Technical specifications

OVERVIEW

Soundproofing	CLASS A 30 DS,A (dB) reduction Speech level reduction DS,A (dB) is measured using ISO 23351-1. Pod can be placed next to workspaces without compromising privacy.
Sound masking	FRAMERY OFFICE SOUND MASKING SYSTEM™ A pre-fitted sound masking system improves the soundscape of the office outside the pods with an effective radius of 5 m / 16 ft.
Ventilation	MAXIMUM AIRFLOW 36 l/s, 76 CFM (129.6 m ³ /h) DEFAULT AIRFLOW 26 l/s, 55 CFM (94 m ³ /h) when in use. After use, the pod refreshes itself with a higher ventilation speed. STANDBY MODE 16 l/s, 34 CFM, (58 m ³ /h)
Lighting	CEILING LIGHT Color temperature 4000K, illuminance up to 500lux on the table top. VIDEO LIGHT Color temperature 4000K, illuminance up to 400lux on the user's face. PRE-SET LIGHTING MODES Standard mode & Video call mode. Lighting can also be adjusted manually.
Presence detection	SENSOR TECHNOLOGY mmWave radar
Dimensions	EXTERIOR 225 × 103 × 100 cm / 88.6 × 40.7 × 39.4 in (h,w,d) WITH CASTERS Additional 0.5 cm / 0.2 in (h) DOORWAY 204 × 85 cm / 80.2 × 33.5 in (h, w) WEIGHT 253 kg / 558 lb THRESHOLD 11.6 cm / 4.6 in (also with casters)
Connectivity	Framery smart pods gather anonymous occupancy data, measuring when and how often spaces are used. Users in the space cannot be identified and no personally identifiable data is collected. The anonymous data is transferred via built-in 4G connectivity, or through a Wi-Fi connection and compiled and shown in the Framery Connect platform. WLAN Wi-Fi 802.11 a/b/g/n/ac 2.4&5 GHz

DIMENSIONS / MAIN VIEW

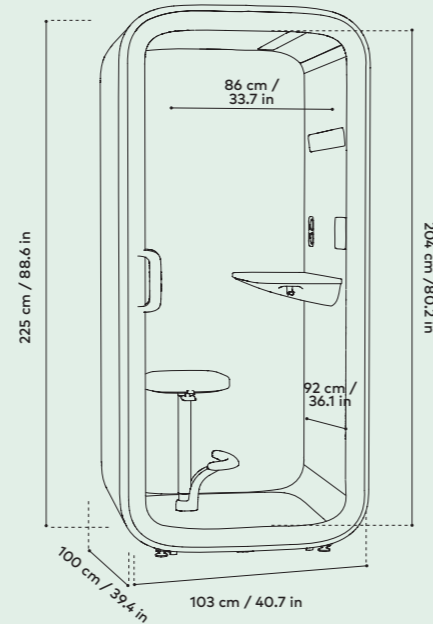

Framery One Compact / Technical specifications

MATERIALS

Exterior & structure	EXTERIOR PANELS Powder coated matt steel panels FRAMES Structure matt black steel DOOR FRAME Matt black aluminum and plastic structure GLASS Sound control laminated glass (4 + 4 mm / 0.16 + 0.16 in) CHASSIS Light steel and PET sound-absorbing structure HANDLE Mix of black plastic and steel
Interior materials	INTERIOR PANELS PET sheets laminated with recycled polyester fabric UPHOLSTERY FABRIC Gabriel Tonal CARPET Antistatic and stain resistant low loop pile carpet TABLE Table top is birch plywood laminated with white, black anti-fingerprint, or oak veneer. The table bottom is black thermoformed felt.
Seating materials	UPHOLSTERY FABRIC Gabriel Select FABRIC COMPOSITION 85 % New Zealand wool / 15 % Polyamide LEG & FOOTREST Steel and aluminum
Furniture dimensions	TABLE SIZE 76.5 × 36 cm / 30 × 14 in (w, d) TABLE HEIGHT 102 cm / 40.2 in MAX LOAD FOR THE TABLE 50 kg / 110 lb SEAT SIZE 38 × 38 cm / 15 × 15 in (w, d) SEAT HEIGHT 59–85 cm / 23.2–33.5 in MAX LOAD FOR THE SEAT 135 kg / 300 lb

DIMENSIONS / TOP VIEW

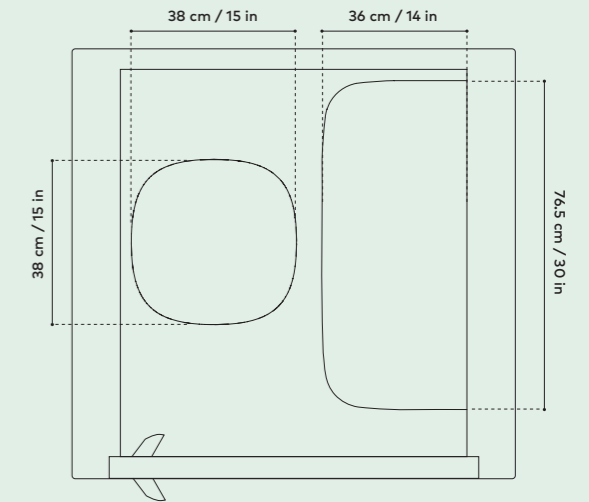

SAFETY

Fire safety	No fire hazardous materials are used in Framery pods. The fire safety of all surface materials, upholstery and acoustics materials of our products are tested and classified by either national or international standards. Framery provides additional safety measurements to adhere to local regulatory requirements.
Seismic safety	A seismic anchoring kit for a pod is available for the seismic regions. The kit consists of brackets that further reinforce the pod structure to withstand heavy seismic forces.



Framery One Compact is UL GREENGUARD GOLD certified



ISO 9001
BUREAU VERITAS
Certification



ISO 14001
BUREAU VERITAS
Certification



Framery One Compact shipped in North America is UL 962 listed

Framery One Compact / Technical specifications

POWER AND SPACE REQUIREMENTS

Power

OUTLETS 1 x power outlet
Optional: 1 x power outlet, 1-2 x USB-C PD charge ports (65W) or 1 x LAN port (with cable)

POWER CONSUMPTION
Default settings 27W. Highest settings 40W.
Standby mode 14W.

INPUT 100–240 VAC, 10 A*, 50–60 Hz

OUTPUT AC (POWER OUTLET)
100–240VAC, 6.6A, 50–60 Hz

OUTPUT USB-C PD CHARGE PORT 65W

*North America: NEMA 5-15P (120v 3-prong)
*India: 16A

Space requirements **DOOR SWING ANGLE 180°**

Door handedness Right-handed by default
(can also be installed left-handed)

Operating space From back to front (pod depth + doorway)
185 cm / 72.9 in. Room height requirement
235 cm / 92.5 in. For seismic anchoring
leave 50 cm / 19.7 in of free space outside of
exterior panel walls. For sprinkler installation
requirements leave 50 cm / 19.7 in of free space
on the outside of the table wall.

Installation space Installation requires 50 cm / 19.7 in of free space
around the pod.

Movability Relocate the pod without the need for
disassembly by adding casters (optional).
Levelling guides must be lifted when moving the
pod, and lowered when placed in position.

SHIPPING CRATE

Dimensions 228.5 x 114.5 x 86.5 cm / 90 x 45.1 x 34.1 in

Weight 310 kg / 683 lb
Crates can be stacked (max 3 boxes)

DIMENSIONS / POWER CORD SPECIFICATIONS

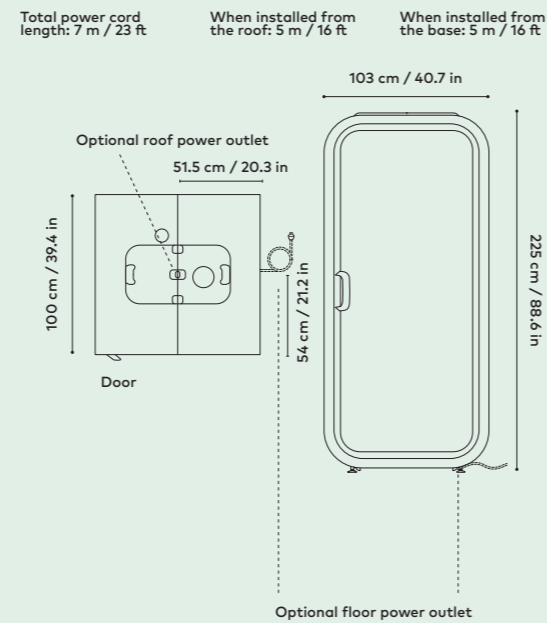

DIMENSIONS / OPERATING SPACE

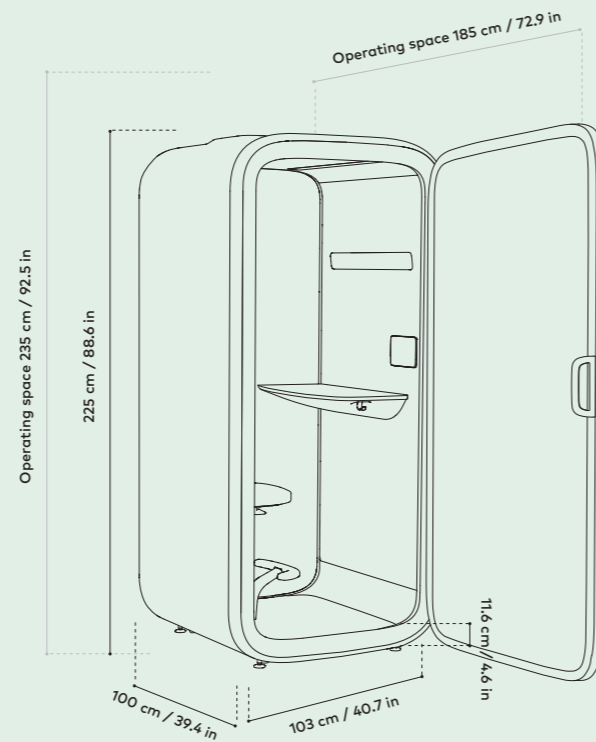

Framery One / Technical specifications

OVERVIEW

Soundproofing **CLASS A 30 DS,A (dB) reduction**
Speech level reduction DS,A (dB) is measured
using ISO 23351-1. Pod can be placed next to
workspaces without compromising privacy.

Ventilation **DEFAULT AIRFLOW 26 l/s, 55 CFM (94 m³/h).**
Airflow can be adjusted manually. After use, the
pod refreshes itself with a higher ventilation
speed.
STANDBY MODE 7 l/s, 15 CFM, (25 m³/h)

Lighting **CEILING LIGHT** Color temperature 4000 K,
illuminance up to 500 lux on the tabletop.
VIDEO LIGHT Color temperature 4000 K,
illuminance up to 400 lux on the user's face.
PRE-SET LIGHTING MODES Standard mode
& Video call mode. Lighting can also be adjusted
manually.

Presence detection **SENSOR TECHNOLOGY** Ultrasonic sensor

Dimensions **EXTERIOR 225.5 x 122 x 100 cm /**
88.8 x 48 x 39.4 in (h, w, d)
WITH CASTERS Additional 3 cm / 1.18 in (h)
WITH AIR FILTER additional 6.5 cm / 2.56 in (h)
WITH SEISMIC KIT additional 2 cm / 0.78 in (h)
DOORWAY 204 x 101.5 cm / 80.3 x 40 in (h, w)
WEIGHT 357 kg / 787 lb (Framery One Lounge:
370 kg / 815.7 lb)
THRESHOLD 11 cm / 4.35 in
(with casters 12.3 cm / 4.85 in)

Connectivity Framery smart pods gather anonymous
occupancy data, measuring when and how
often spaces are used. Users in the space cannot
be identified and no personally identifiable data
is collected. The anonymous data is transferred
via built-in 4G connectivity, and compiled and
shown in the Framery Connect platform.

DIMENSIONS / MAIN VIEW

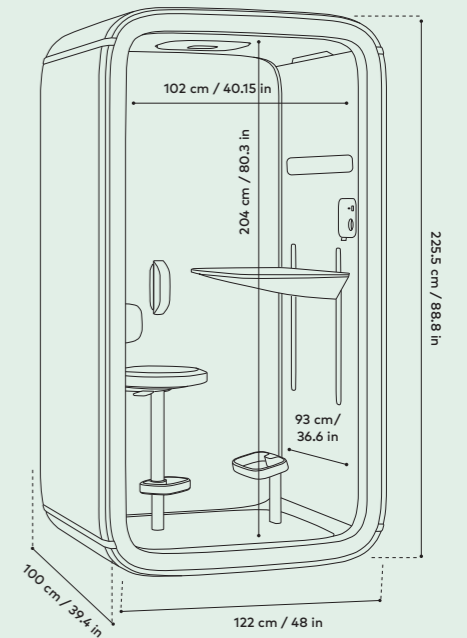

DIMENSIONS / HEIGHT ADJUSTABLE SEAT AND TABLE / FRONT VIEW

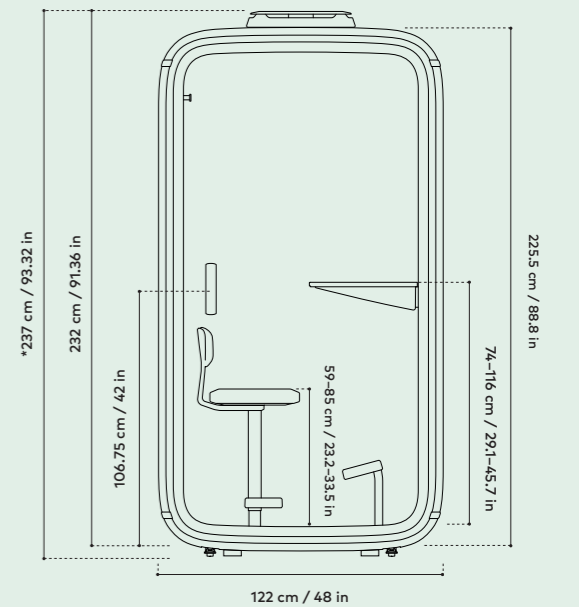

*including air filter, casters and seismic kit.



Framery One shipped in North
America is UL 962 listed

Framery One / Technical specifications

MATERIALS

Exterior & structure

EXTERIOR PANELS Powder coated matt steel panels

FRAMES Structure matt black frames made from steel & aluminum

DOOR FRAME Matt black composite structure

GLASS Sound control laminated glass (4 + 4 mm / 0.16 + 0.16 in.)

CHASSIS A sandwich element chassis, made of sheet metal & recycled acoustic foam

HANDLE Black cast aluminum

Interior materials

INTERIOR PANELS PET sheets which are laminated with recycled polyester fabric

UPHOLSTERY FABRIC Gabriel Tonal

CARPET Antistatic and stain resistant low loop pile carpet

TABLE Table top is birch plywood laminated with white, black anti-fingerprint, or oak veneer. The table bottom is black thermoformed felt

Seating materials

UPHOLSTERY FABRIC Gabriel Select

FABRIC COMPOSITION 85 % New Zealand wool / 15 % Polyamide

STOOL & FOOTREST Steel, aluminum & plastic (Carpet also included for the Framery One Lounge footrest)

Furniture dimensions

TABLE SIZE 76.5 x 46 cm / 30.1 x 18 in (w, d)

TABLE HEIGHT 74–116 cm / 29.1–45.7 in (Framery One Lounge with fixed table 88 cm / 34.6 in)

MAX LOAD FOR THE TABLE 50 kg / 110 lb

SEAT SIZE 38 x 38 cm / 15 x 15 in (d, w) (Framery One Lounge 40.2 x 60.7 cm / 15.8 in x 23.9 in)

SEAT HEIGHT 59–85 cm / 23.2–33.5 in (Framery One Lounge 62 cm / 24.4 in)

MAX LOAD FOR THE SEAT 135 kg / 300 lb (Framery One Lounge 200kg / 441 lb)

Optional accessories

MONITOR WALL MOUNT Maximum monitor size 24". Maximum weight 5 kg / 11 lbs with flat VESA 100 x 100 mounting surface. Monitor not included.

SHIPPING CRATE

Dimensions

229 x 131 x 88 cm / 90.15 x 51.6 x 34.6 in (Framery One Lounge also includes a second crate 80 x 60 x 70 cm / 31.5 x 23.6 x 27.6 in.)

Weight

430 kg / 948 lb (Framery One Lounge 464 kg / 1023 lb). Crates can be stacked (max 3 boxes).

DIMENSIONS / HEIGHT ADJUSTABLE SEAT AND TABLE / TOP VIEW

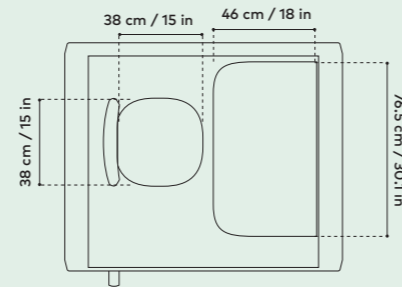

DIMENSIONS / LOUNGE SEAT AND FIXED TABLE / FRONT VIEW

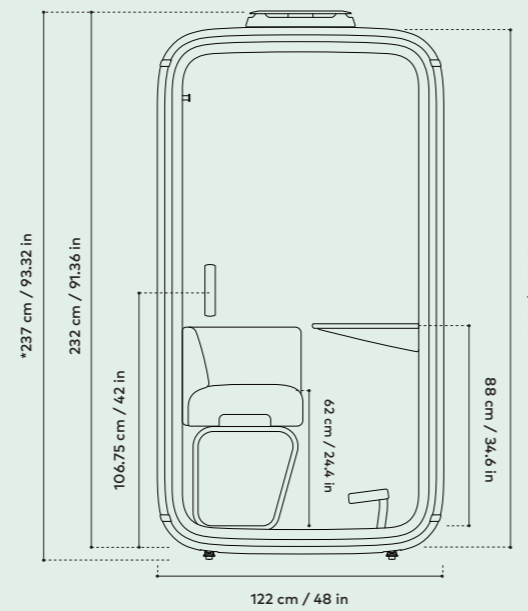

DIMENSIONS / LOUNGE SEAT AND FIXED TABLE / TOP VIEW

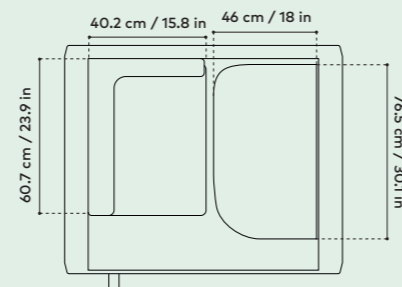

Framery One / Technical specifications

POWER AND SPACE REQUIREMENTS

Power

OUTLETS 1 x power outlet, 1 x USB-C charge port (15W)

Optional: 1 x LAN port (with cable)

POWER CONSUMPTION

Default settings 28W. Highest settings 37W

Standby mode 6W

INPUT 100–240 VAC, 10 A*, 50–60 Hz

OUTPUT AC (POWER OUTLET)

100–240VAC, 6.6A, 50–60 Hz

OUTPUT USB-C CHARGE PORT 15W

*North America: NEMA 5-15P (120v 3-prong)

*India: 16A

Space requirements

DOOR SWING ANGLE 90°

Door handedness

Right-handed by default (can also be installed left-handed)

Operating space

From back to front (pod depth + doorway): 201.5 cm / 79.4 in. Room height requirement: 240 cm / 94.5 in. For seismic anchoring or sprinklers leave 50 cm / 19.7 in of free space around the sides of the pod. The pod can be anchored next to the wall with optional casters.

Installation space

Installation requires 50 cm / 19.7 in of free space around the pod

Movability

Relocate the pod without the need for disassembly by adding casters (optional). Levelling guides must be lifted when moving the pod, and lowered when placed in position.

SAFETY

Fire safety

No fire hazardous materials are used in Framery pods. The fire safety of all surface materials, upholstery and acoustics materials of our products are tested and classified by either national or international standards. Framery provides additional safety measurements to adhere to local regulatory requirements.

Seismic safety

A seismic anchoring kit for a pod is available for the seismic regions. The kit consists of brackets that further reinforce the pod structure to withstand heavy seismic forces.

DIMENSIONS / POWER CORD SPECIFICATIONS

Total power cord length: 7 m / 23 ft

When installed from the roof: 5 m / 16 ft

When installed from the base: 5 m / 16 ft

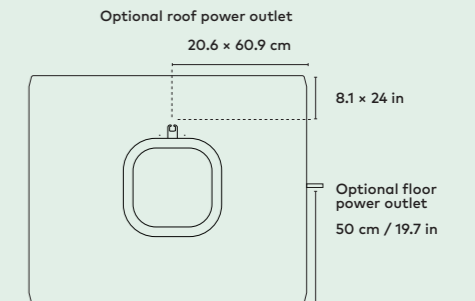

DIMENSIONS / OPERATING SPACE

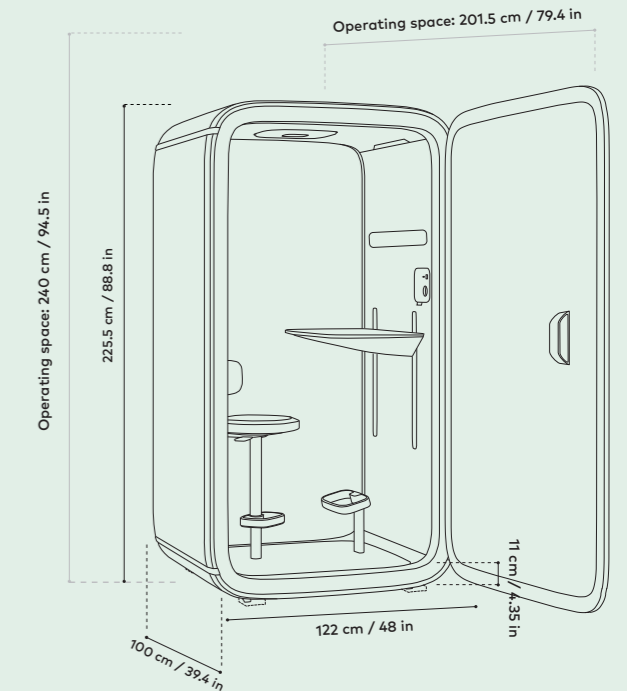

Framery Four / Technical specifications

OVERVIEW

Soundproofing	CLASS A 30 DS,A (dB) reduction Speech level reduction DS,A (dB) is measured using ISO 23351-1. Pod can be placed next to workspaces without compromising privacy.
Sound masking	FRAMERY OFFICE SOUND MASKING SYSTEM™ A pre-fitted sound masking system improves the soundscape of the office outside the pods with an effective radius of 5 m / 16 ft.
Ventilation	MAXIMUM AIRFLOW 100 l/s, 212 CFM (360.2 m ³ /h) DEFAULT AIRFLOW 78 l/s, 165 CFM (280 m ³ /h) when in use. After use, the pod refreshes itself with a higher ventilation speed. STANDBY MODE 40 l/s, 85 CFM, (144 m ³ /h) ADJUSTABLE DIRECTIONAL AIRFLOW Choose between direct and indirect airflow
Lighting	CEILING LIGHT Color temperature 4000K, illuminance up to 500lux on the table top. VIDEO LIGHT Color temperature 4000K, illuminance up to 350lux on the user's face. PRE-SET LIGHTING MODES Standard mode & Video call mode. Lighting can also be adjusted also manually.
Presence detection	SENSOR TECHNOLOGY mmWave radar
Dimensions	EXTERIOR with air filter housing 232.9 × 235.2 × 129.2 cm / 91.7 × 92.6 × 50.9 in (h, w, d) DOORWAY 209.7 × 96.6 cm / 82.6 × 38 in (h, w) WEIGHT 520 kg / 1146.4 lb (Framery Four Base 460 kg / 208.7 lb) THRESHOLD 1.25 cm / 0.5 in
Touchscreen location	On the table (Framery Four Base: on the wall, right side)
Connectivity	Framery smart pods gather anonymous occupancy data, measuring when and how often spaces are used. Users in the space cannot be identified and no personally identifiable data is collected. The anonymous data is transferred via built-in 4G connectivity, or through a Wi-Fi connection and compiled and shown in the Framery Connect platform. WLAN Wi-Fi 802.11 a/b/g/n/ac 2.4&5 GHz.

DIMENSIONS / MAIN VIEW

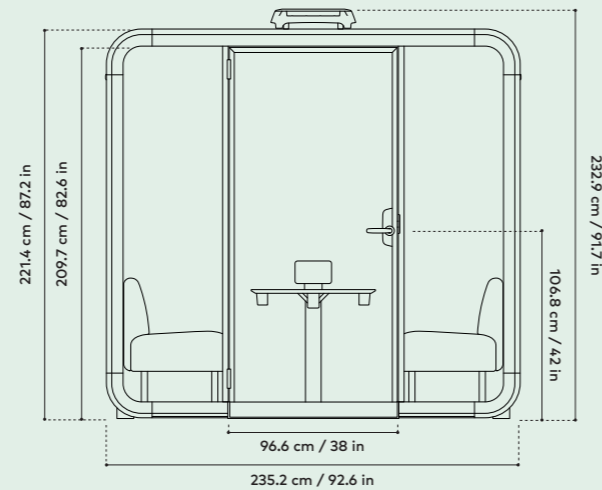
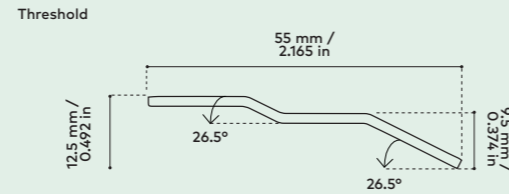
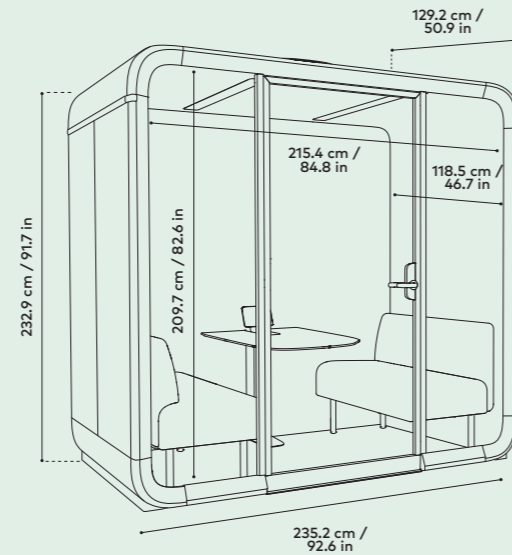

Framery Four / Technical specifications

MATERIALS

Exterior & structure	EXTERIOR PANELS Powder coated matt steel panels. FRAMES Structure matt black aluminum DOOR FRAME Structure matt black aluminum GLASS Sound control laminated glass (4 + 4 mm / 0.16 + 0.16 in) CHASSIS Light steel and PET sound-absorbing structure HANDLE Custom-designed black metal
Interior materials	INTERIOR PANELS PET sheets laminated with recycled polyester fabric UPHOLSTERY FABRIC Gabriel Tonal CARPET Antistatic and stain resistant low loop pile carpet. CUSHIONS Gabriel Capture TABLE Table top is birch plywood laminated with white, black anti-fingerprint, or oak veneer TABLE LEG Structure black metal
Seating materials	UPHOLSTERY FABRIC Gabriel Select FABRIC COMPOSITION 85 % New Zealand wool / 15 % Polyamide
Furniture dimensions	TABLE 70.6 cm × 90 cm / 27.8 × 35.4 in (w, d) Fixed height from floor 71.9 cm / 28.3 in MAX LOAD FOR THE TABLE 60 kg / 131 lb SOFA 110 × 60.5 cm (w, d) / 43.3 in × 23.8 in. Fixed seating height from floor 47 cm / 18.5 in (backrest height cm 78,5 / 30.9 in) MAX LOAD FOR SOFA 408 kg / 900 lb
Optional accessories	WHITEBOARD 102.2 × 112 cm / 40.2 × 44 in (h, w) ROTATING MONITOR ARM Max monitor size 24"–27". Max weight 15 kg / 33 lbs with a flat 75 × 75 or 100 × 100 center-positioned VESA mounting surface. Monitor not included. COAT HOOKS Structure black metal CUSHIONS Gabriel Capture—85 % New Zealand wool / 15 % Polyamide EXTERIOR TABLET MOUNT With easy set-up SMART LOCK Locking capability with different entry methods.

DIMENSIONS / TOP VIEW

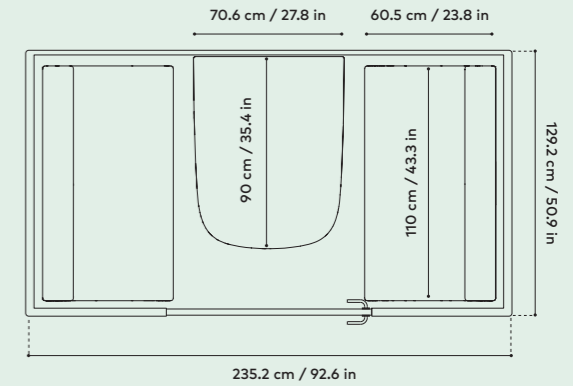

SAFETY

Fire safety	No fire hazardous materials are used in Framery pods. The fire safety of all surface materials, upholstery and acoustics materials of our products are tested and classified by either national or international standards. Framery provides additional safety measurements to adhere to local regulatory requirements.
Seismic safety	A seismic anchoring kit for a pod is available for the seismic regions. The kit consists of brackets that further reinforce the pod structure to withstand heavy seismic forces.



Framery Four shipped in North America is UL 962 listed

Framery Four / Technical specifications

POWER AND SPACE REQUIREMENTS

Power

FRAMERY FOUR ESSENTIALS OUTLETS
4 x under-table power outlets, 2 x USB-C PD charge ports (65 W). Optional: 2 x under-table power outlets (included with the monitor arm).
Optional in-table outlets (max. 2): 0-1 x HDMI port, 0-2 x LAN ports (with cables)

FRAMERY FOUR LITE OUTLETS
4 x under-table power outlets. Optional: 2 x under-table power outlets (included with the monitor arm). Optional in-table outlets (max 4): 0-2 x USB-C PD charge ports (65 W), 0-1 x HDMI port, 0-4 x LAN ports (with cables)

FRAMERY FOUR BASE OUTLETS
4 x power outlets (2 x power outlets on each side of the pod). Optional outlets (max 4): 0-2 x USB-C PD charge ports (65 W), 0-4 x LAN ports (with cables)

POWER CONSUMPTION Default settings 52W. Highest settings 115W. Standby mode 20W. **INPUT** 100-240 VAC, 10 A*, 50-60 Hz. **OUTPUT AC (POWER OUTLET)** 100-240 VAC (8 A max) 50-60 Hz. **OUTPUT USB-C PD CHARGE PORT** 65W

*North America: NEMA 5-15P (120v 3-prong)

*India: 16A

Space requirements **DOOR SWING ANGLE** 180°

Door handedness Left-handed by default (can also be installed right-handed)

Operating space From back to front (pod depth + doorway) 225.8 cm / 88.9 in. Room height requirement 238 cm / 93.7 in.

Installation space Installation requires 50 cm / 19.7 in of free space around the pod. Room height requirement 238 cm / 93.7 in.

Movability Relocate the pod without the need for disassembly by adding casters with a movability kit. Compatible with Framery Four and Six. The kit is reusable. Multiple pods can be moved with one kit.

SHIPPING CRATE DIMENSIONS

Crate 1 **SIZE** 226 x 75 x 138 cm / 90 x 29.5 x 54.3 in (l, w, h). **WEIGHT** 278 kg / 612.9 lb

Crate 2 **SIZE** 224 x 74 x 114 cm / 88.2 x 29.1 x 44.9 in (l, w, h). **WEIGHT** 395 kg / 870.8 lb

Crate 1 is stacked on top of Crate 2

DIMENSIONS / POWER CORD SPECIFICATIONS

Total power cord length: 7 m / 23 ft
When installed from the roof: 4 m / 13 ft
When installed from the base: 6.5 m / 21 ft (right), 4 m / 13 ft (left)

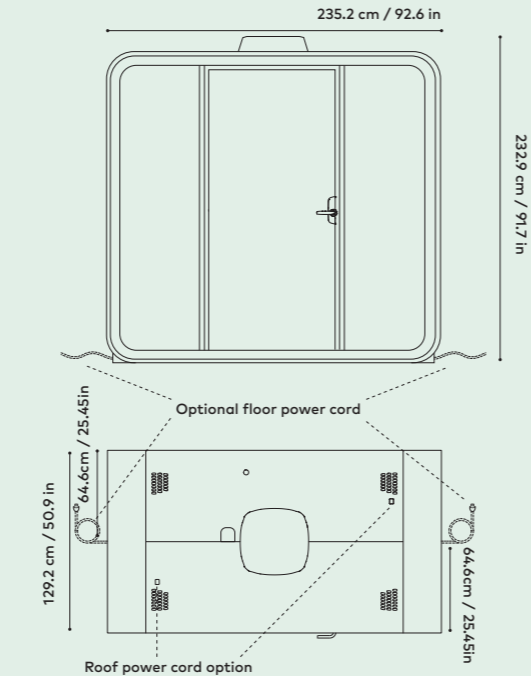

DIMENSIONS / OPERATING SPACE

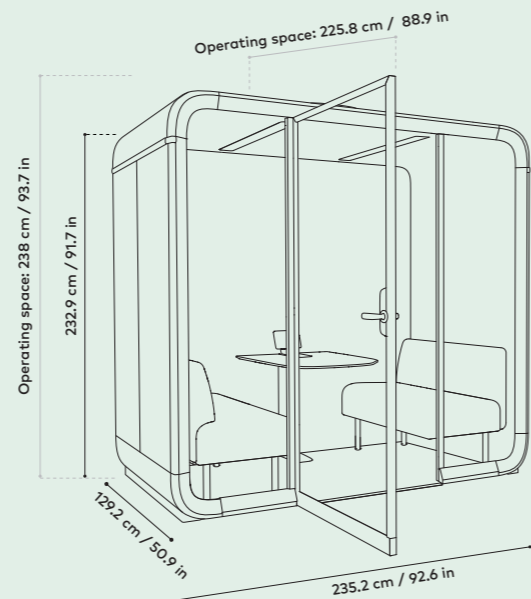

Framery Four Accessible / Technical specifications

OVERVIEW

Soundproofing **CLASS A 30 DS,A (dB) reduction**
Speech level reduction DS,A (dB) is measured using ISO 23351-1. Pod can be placed next to workspaces without compromising privacy.

Sound masking **FRAMERY OFFICE SOUND MASKING SYSTEM™** A pre-fitted sound masking system improves the soundscape of the office outside the pods with an effective radius of 5 m / 16 ft

Ventilation **MAXIMUM AIRFLOW** 100 l/s, 212 CFM (360.2 m³/h)
DEFAULT AIRFLOW 78 l/s, 165 CFM (280 m³/h) when in use. After use, the pod refreshes itself with a higher ventilation speed.
STANDBY MODE 40 l/s, 85 CFM, (144 m³/h)
ADJUSTABLE DIRECTIONAL AIRFLOW Choose between direct and indirect airflow

Lighting **CEILING LIGHT** Color temperature 4000K, illuminance up to 500lux on the table top.
VIDEO LIGHT Color temperature 4000K, illuminance up to 350lux on the user's face.
PRE-SET LIGHTING MODES Standard mode & Video call mode. Lighting can also be adjusted also manually.

Presence detection **SENSOR TECHNOLOGY** mmWave radar

Dimensions **EXTERIOR WITH AIR FILTER HOUSING** 232.9 x 235.2 x 129.2 cm / 91.7 x 92.6 x 50.9 in (h, w, d)
DOORWAY 209.7 x 96.6 cm / 82.6 x 38 in (h, w)
WEIGHT 560 kg / 1234.6 lb.
THRESHOLD 1.27 cm / 0.5 in

Touchscreen location On the right side of the table, on the accessory rail

Connectivity Framery smart pods gather anonymous occupancy data, measuring when and how often spaces are used. Users in the space cannot be identified and no personally identifiable data is collected. The anonymous data is transferred via built-in 4G connectivity, or through a Wi-Fi connection and compiled and shown in the Framery Connect platform. **WLAN** Wi-Fi 802.11 a/b/g/n/ac 2.4&5 GHz

DIMENSIONS / MAIN VIEW

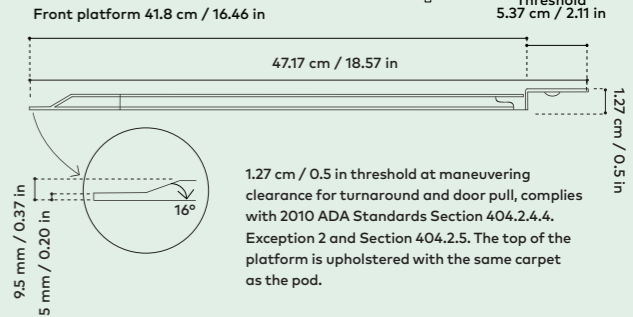
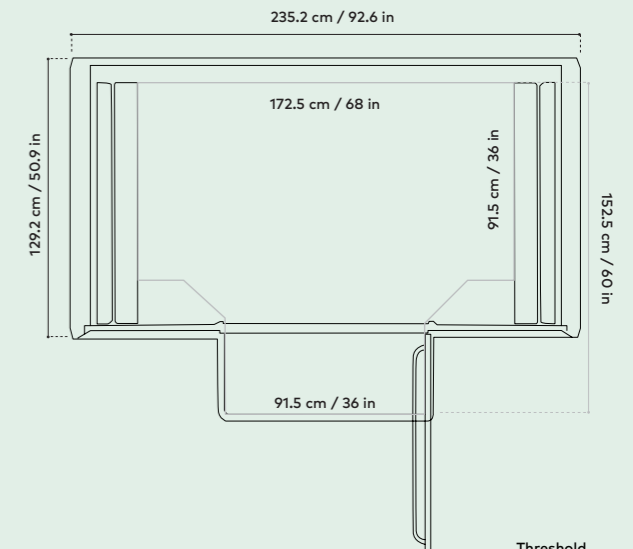
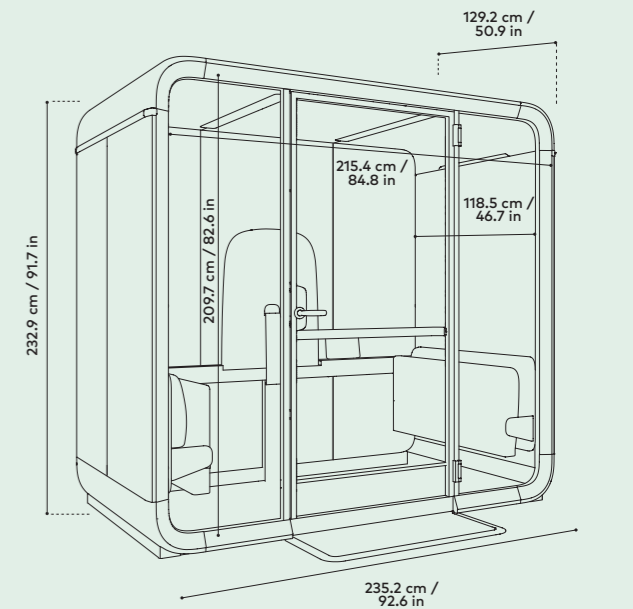

Framery Four Accessible is UL GREENGUARD GOLD certified



Framery Four Accessible shipped in North America is UL 962 listed

Framery Four Accessible / Technical specifications

MATERIALS

Exterior & structure

EXTERIOR PANELS Powder coated matt steel panels
FRAMES Structure matt black aluminum
DOOR FRAME Structure matt black aluminum
GLASS Sound control laminated glass (4 + 4 mm / 0.16 + 0.16 in)
CHASSIS Light steel and PET soundabsorbing structure
HANDLE AND PULL BAR Custom-designed black metal
DOOR KICK PLATES Black metal

Interior materials

INTERIOR PANELS PET sheets laminated with recycled polyester fabric
UPHOLSTERY FABRIC Gabriel Tonal
CARPET Antistatic and stain resistant low loop pile carpet
TABLE TOP is birch plywood laminated with white, black anti-fingerprint, or oak.
TABLE LEG AND ACCESSORY RAIL Structure black metal

Seating materials

UPHOLSTERY FABRIC Gabriel Select **FABRIC COMPOSITION** 85 % New Zealand wool / 15 % Polyamide

Furniture dimensions

FOLDING TABLE 63.3 x 87 cm / 24.9 x 34.3 in (w, d). Fixed height from floor 71.9 cm / 28.3 in. Forces: max 22.2N
FOLDING SOFA width 110 cm / in. Fixed seating height from floor 48.5 cm / 19 in. Max load for the sofa: 408 kg / 900 lb.
PULL BAR Height from pod floor: 92.1 cm / 36.3 in.

Optional accessories

WHITEBOARD 102.2 x 112 cm / 40.2 x 44 in (h, w)
COAT HOOKS Structure black metal
EXTERIOR TABLET MOUNT With easy set-up
SMART LOCK Locking capability with different entry methods.

SAFETY

Fire safety

No fire hazardous materials are used in Framery pods. The fire safety of all surface materials, upholstery and acoustics materials of our products are tested and classified by either national or international standards. Framery provides additional safety measurements to adhere to local regulatory requirements.

Seismic safety

A seismic anchoring kit for a pod is available for the seismic regions. The kit consists of brackets that further reinforce the pod structure to withstand heavy seismic forces.

DIMENSIONS / TOP VIEW

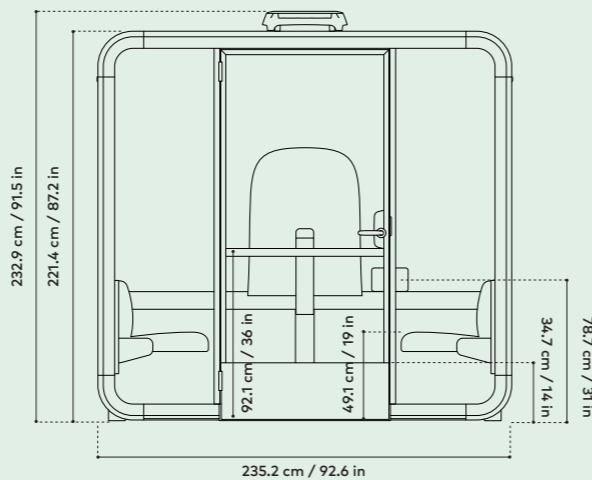
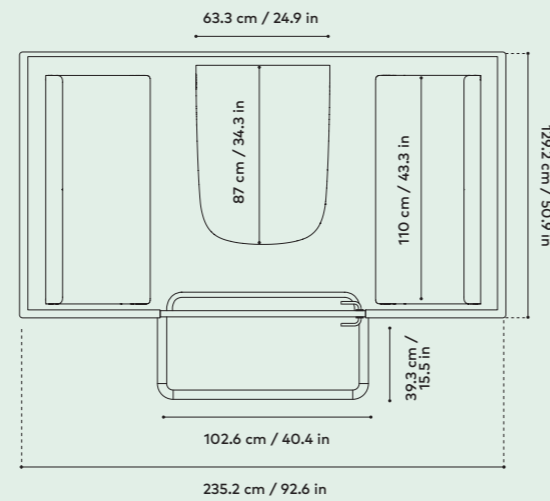

Framery Four Accessible / Technical specifications

POWER AND SPACE REQUIREMENTS

Power

FRAMERY FOUR ACCESSIBLE OUTLETS
 4 x power outlets (2 on both sides of the table attached to the accessory rail).
 Optional additional outlets (max 4):
 0-2 x USB-C PD charge ports (65 W),
 0-4 x LAN ports (with cables)

POWER CONSUMPTION
 Default settings 52W. Highest settings 115W. Standby mode 20W.

INPUT 100-240 VAC, 10 A*, 50-60 Hz

OUTPUT AC (POWER OUTLET)
 100-240 VAC (8 A max) 50-60 Hz

OUTPUT USB-C PD CHARGE PORT 65W

*North America: NEMA 5-15P (120v 3-prong)

*India: 16A

Space requirements

DOOR SWING ANGLE 180°

Door handedness

Left-handed by default (can also be installed right-handed)

Operating space

From back to front (pod depth + doorway) 225.8 cm / 88.9 in. Room height requirement 238 cm / 93.7 in.

Installation space

Installation requires 50 cm / 19.7 in of free space around the pod. Room height requirement 238 cm / 93.7 in.

Movability

Relocate the pod without the need for disassembly by adding casters with a movability kit. Compatible with Framery Four and Six. The kit is reusable. Multiple pods can be moved with one kit.

SHIPPING CRATE DIMENSIONS

Crate 1

SIZE 226 x 75 x 138 cm / 90 x 29.5 x 54.3 in (l, w, h)
WEIGHT 278 kg / 612.9 lb

Crate 2

SIZE 224 x 74 x 114 cm / 88.2 x 29.1 x 44.9 in (l, w, h)
WEIGHT 395 kg / 870.8 lb

Crate 1 is stacked on top of Crate 2

DIMENSIONS / POWER CORD SPECIFICATIONS

Total power cord length: 7 m / 23 ft

When installed from the roof: 4 m / 13 ft

When installed from the base: 6.5 m / 21 ft (right), 4 m / 13 ft (left)

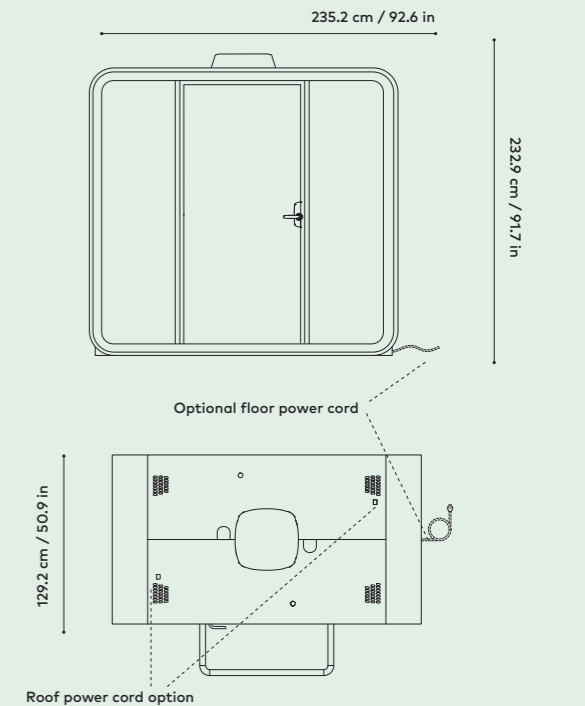

DIMENSIONS / OPERATING SPACE

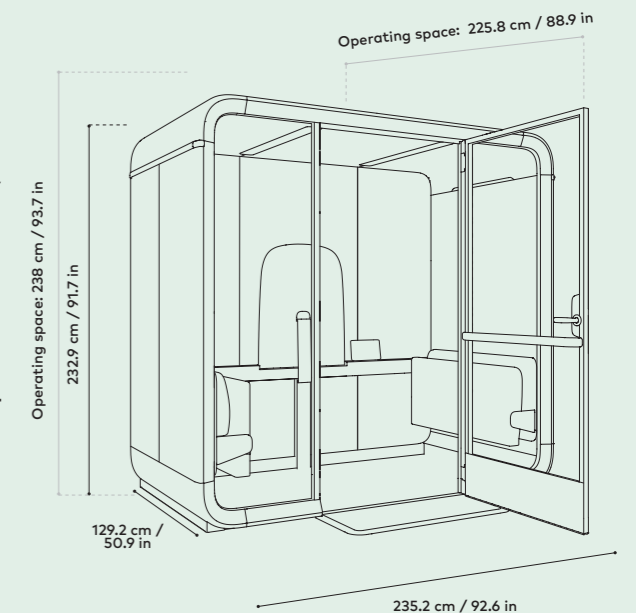

Framery Six / Technical specifications

OVERVIEW

Soundproofing	CLASS A 30 DS,A (dB) reduction Speech level reduction DS,A (dB) is measured using ISO 23351-1. Pod can be placed next to workspaces without compromising privacy.
Sound masking	FRAMERY OFFICE SOUND MASKING SYSTEM™ A pre-fitted sound masking system improves the soundscape of the office outside the pods with an effective radius of 5 m / 16 ft
Ventilation	MAXIMUM AIRFLOW 187 l/s, 397 CFM (674.6 m ³ /h) DEFAULT AIRFLOW 149 l/s, 316 CFM (536 m ³ /h) when in use. After use, the pod refreshes itself with a higher ventilation speed. ON STANDBY MODE 76 l/s, 161 CFM (274 m ³ /h) ADJUSTABLE DIRECTIONAL AIRFLOW Choose between direct and indirect airflow
Lighting	CEILING LIGHT Color temperature 4000K, illuminance up to 500lux on the table top. VIDEO LIGHT Color temperature 4000K, illuminance up to 350lux on the user's face. PRE-SET LIGHTING MODES Standard mode & Video call mode. The lighting can also be adjusted manually.
Presence detection	SENSOR TECHNOLOGY mmWave radar
Dimensions	EXTERIOR with air filter housing 232.9 × 235.2 × 263.2 cm / 91.7 × 92.6 × 103.6 in (h, w, d) DOORWAY 209.7 × 96.6 cm / 82.6 × 38 in (h, w) WEIGHT 718 kg / 1582.9 lb (Framery Six Base 693 kg / 1527.8 lb) THRESHOLD 1.25 cm / 0.5 in
Touchscreen location	On the table (Framery Six Base: on the wall)
Connectivity	Framery smart pods gather anonymous occupancy data, measuring when and how often spaces are used. Users in the space cannot be identified and no personally identifiable data is collected. The anonymous data is transferred via built-in 4G connectivity, or through a Wi-Fi connection and compiled and shown in the Framery Connect platform. WLAN Wi-Fi 802.11 a/b/g/n/ac 2.4&5 GHz

DIMENSIONS / MAIN VIEW

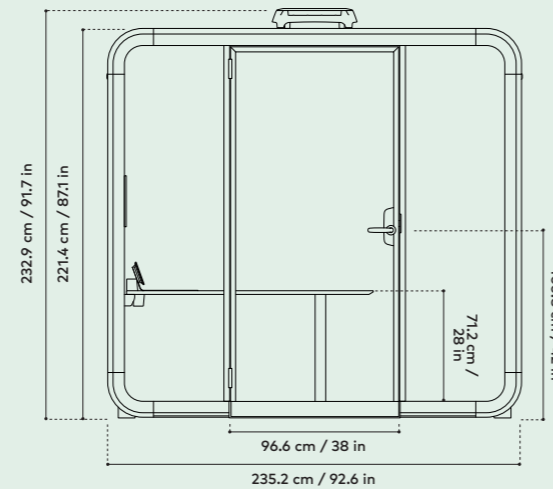
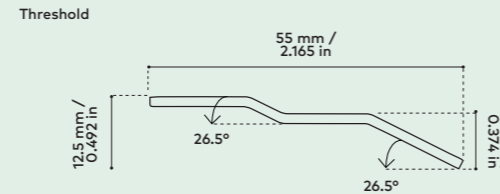
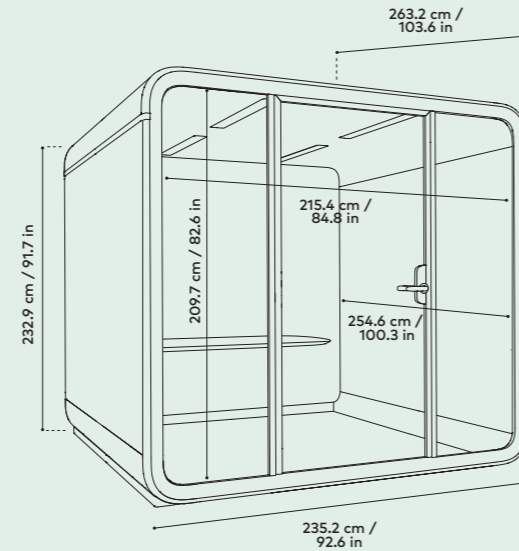

Framery Six / Technical specifications

MATERIALS

Exterior & structure	EXTERIOR PANELS Powder coated matt steel panels FRAMES Structure matt black aluminum. DOOR FRAME Structure matt black aluminum GLASS Sound control laminated glass (4 + 4 mm / 0.16 + 0.16 in) CHASSIS Light steel and PET sound-absorbing structure HANDLE Custom designed black metal
Interior materials	INTERIOR PANELS PET sheets laminated with recycled polyester fabric UPHOLSTERY FABRIC Gabriel Tonal CARPET Antistatic and stain resistant low loop pile carpet. TABLE Table top is birch plywood laminated with white, black anti-fingerprint, or oak veneer. TABLE LEG Structure black metal
Furniture dimensions	TABLE 94 cm × 140 cm / 37 in × 55.1 in (w, d) Fixed height from floor 71.2 cm / 28 in MAX LOAD FOR THE TABLE 60 kg / 131 lb
Optional accessories	INTERIOR WHITEBOARD 102.3 × 206.3 cm / 40.3 × 81.2 in (h, w) MONITOR WALL MOUNT Maximum monitor size 50". Maximum weight 30 kg / 66 lbs with flat VESA 100 × 100, 200 × 100, 200 × 200, 300 × 200, 300 × 300, 400 × 200, 400 × 300 or 400 × 400 mounting surface. Monitor not included. Possibility to mount on both walls. COAT HOOKS Structure black metal EXTERIOR TABLET MOUNT With easy set-up. GATHER ZONE Includes the same whiteboard and monitor wall mount as interior, and additional exterior carpet. SMART LOCK Locking capability with different entry methods.

DIMENSIONS / TOP VIEW

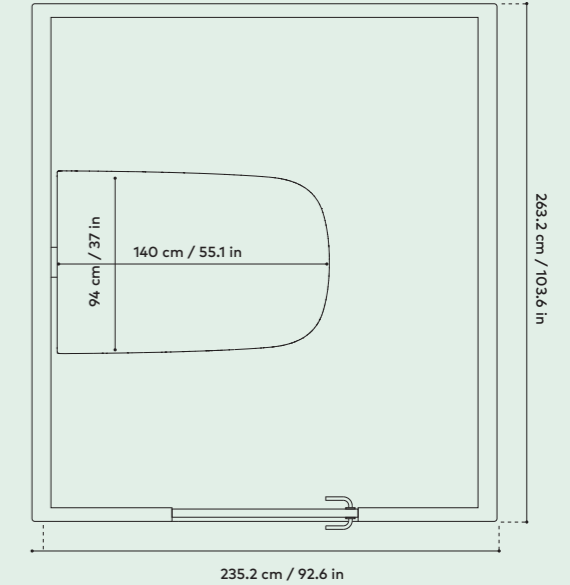

SAFETY

Fire safety	No fire hazardous materials are used in Framery pods. The fire safety of all surface materials, upholstery and acoustics materials of our products are tested and classified by either national or international standards. Framery provides additional safety measurements to adhere to local regulatory requirements.
Seismic safety	A seismic anchoring kit for a pod is available for the seismic regions. The kit consists of brackets that further reinforce the pod structure to withstand heavy seismic forces.



Framery Six is UL GREENGUARD GOLD certified



Framery Six shipped in North America is UL 962 listed

Framery Six / Technical specifications

POWER

Power

FRAMERY SIX ESSENTIALS OUTLETS

2 x on-table outlets, 2 x under-table power outlets, 2 x in-table USB-C PD charge ports (65 W). Optional 2 x under-table power outlets. Optional in-table outlets (max 2) 0-1 x HDMI port, 0-2 x LAN ports (with cables)

FRAMERY SIX LITE OUTLETS 2 x on-table power outlets, 2 x under-table power outlets. Optional 2 x under-table power outlets. Optional in-table outlets (max 4) 0-2 x USB-C PD charge ports (65 W), 0-1 x HDMI port, 0-4 x LAN ports (with cables)

FRAMERY SIX BASE OUTLETS 4 x power outlets on the same side of the pod as the touchscreen. Optional outlets (max 4): 0-2 x USB-C PD charge ports (65 W), 0-4 x LAN ports (with cables)

POWER CONSUMPTION Default settings 145W. Highest settings 202W. Standby mode 28W

INPUT 100-240 VAC, 10 A*, 50-60 Hz

OUTPUT AC (POWER OUTLET) 100-40 VAC (8 A max) 50-60 Hz

OUTPUT USB-C PD CHARGE PORT 65W

*North America: NEMA 5-15P (120v 3-prong)

*India: 16A

DIMENSIONS / POWER CORD SPECIFICATIONS

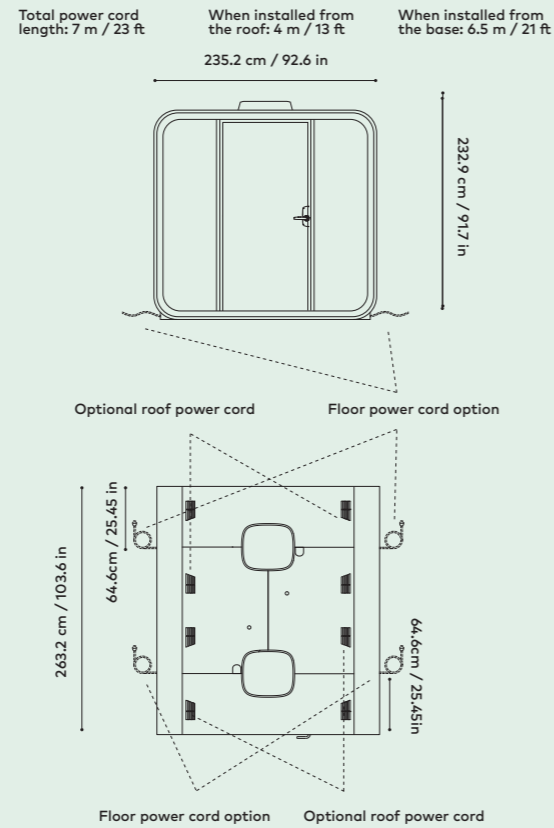

Framery Six / Technical specifications

SPACE REQUIREMENTS

Space requirements	DOOR SWING ANGLE 180°
Door handedness	Left-handed by default (can also be installed right-handed)
Operating space	From back to front (pod depth + doorway) 359.8 cm / 141.6 in. Room height requirement 238 cm / 93.7 in.
Installation space	Installation requires 50 cm / 19.7 in of free space around the pod. Room height requirement 238 cm / 93.7 in.
Movability	Relocate the pod without the need for disassembly by adding casters with a movability kit. Compatible with Framery Four and Six. The kit is reusable. Multiple pods can be moved with one kit.

SHIPPING CRATE DIMENSIONS

Crate 1	SIZE 222 x 89 x 149 cm / 87.4 x 35 x 58.7 in (l, w, h). WEIGHT 392 kg / 864 lb
Crate 2	SIZE 224 x 113 x 116 cm / 88.2 x 44.5 x 46.7 in (l, w, h). WEIGHT 505 kg / 1113 lb
Crate 1 is stacked on top of Crate 2	

DIMENSIONS / OPERATING SPACE

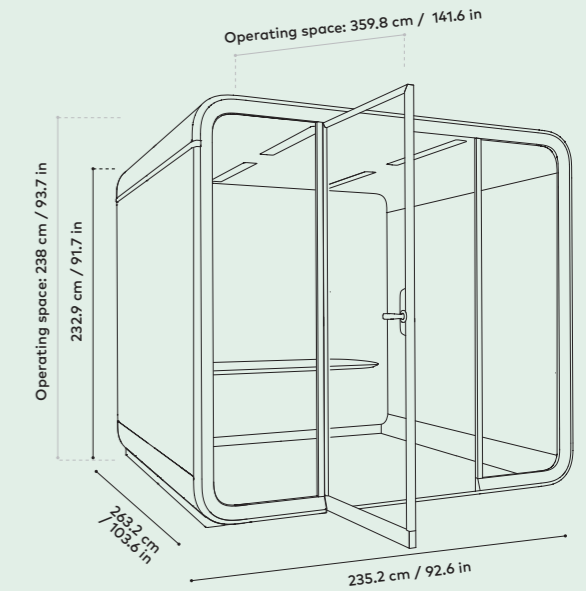

Product safety

Framery's management system has been certified according to the ISO 9001 Quality Management System standard, ISO 14001 Environmental Management System standard, and ISO 45001 Occupational Health and Safety Management System standard. CE marking is a manufacturer's declaration that a product meets the requirements of relevant EC directives. The EC directives for Framery One Compact, One, Four and Six are: Low Voltage Directive (LVD) 2014/35/EU, Electromagnetic Compatibility Directive (EMC) 2014/30/EU, Restriction of Hazardous Substances (RoHS) Directive 2011/65/ EU, Ecodesign Directive 2009/125/EC and the Radio Equipment Directive (RED) 2014/53/EU. All Framery products are also UL listed for US & Canadian markets.

Acoustics

Phone booths and meeting pods can be used to eliminate distractions and increase productivity in the workplace, but this is only achieved if they are actively used. To reach their full potential, pods must be placed close enough to their users. This creates certain requirements especially in terms of sound insulation. The required level of sound insulation for pods, expressed in practical terms, is that they can be placed right next to workstations in an office and people working outside them will not be able to overhear discussions inside. This is especially important in the case of on-demand use of single-person pods.

ISO 23351-1 is a standard that can be used to measure the level of pods' sound insulation as a whole and to produce a single figure, called speech level reduction, which describes the degree of provided speech privacy. A speech level reduction of 30 dB corresponds with the practical requirement of sound insulation mentioned above. With a lower level of sound insulation, pods should be placed further away from people working outside them.

In addition to sound insulation, interior acoustics of pods are another factor to take into consideration. Poor interior acoustics make it difficult to hear what is said during phone calls and meetings. This also causes users to raise their voices, which creates another problem in terms of privacy.

Reverberation time is typically used to describe the interior acoustics of a space. Unfortunately, it's not possible to reliably test reverberation time in pods because of their small size. However, the surface area and thickness of absorptive materials inside a pod are good indicators of its acoustics. Also, as with sound insulation, it is important to test pods in practice and make sure that speech sounds natural inside them.

Framery One, One Compact, Four and Six

FIRE SAFETY No fire hazardous materials are used in Framery products. The fire safety of all surface materials, upholstery and acoustics materials of our products are tested and classified by either national or international standards. The sheet metal exteriors and sound-control laminated glass are of such quality that they may halt heat and fire. Acoustic felt fibers we use meet B-s1, d0, EN 13501-1; acoustic panels B-s2, d0, EN 13501-1 and floor carpet Bfl-s1, EN 13501-1 requirements. Interior panels in Framery products meet ASTM E84: Class A. Seat materials used in the seating provided by Framery meet CA TB 117:2013 requirements. Fabric used in upholstery meets the performance requirements of EN 1021-1 and 1 021-2.

MATERIAL SAFETY All Framery products are certified against UL GreenGuard. Framery One Compact, One, Four and Six have achieved the highest possible GreenGuard Gold certification level. We want to embrace transparency of the materials we use for our products and thus we will have Health Product Declarations® (HPD) and Declare labels available for our products. Our HPDs can be found and downloaded for free online from the Health Product Declaration Collaborative public repository and Declare labels can be found from International Living Future Institutes Declare label product library.

For more Framery product information
visit us online at framery.com

Trademarks FRAMERY®, framery™, Framery One™, Framery One Compact™, Framery Four™, Framery Six™ Framery Connect™, Framery App™, Framery Connect Sensor™, Framery Room Display™, Framery Plus™, Framery Office Sound Masking System™ and Framery Space Overview™ are property of Framery Oy. For more comprehensive details of intellectual property rights of Framery Oy, please see www.framery.com/en/ipr.
Framery Magazine—The work-comfort issue

©2025 Framery
All rights reserved. All specifications subject to change without notice.

Framery is the industry
pioneer and global
leader in engineering and
manufacturing soundproof
pods, services, and solutions
that enable people at work
to connect and focus on
what really matters.

framery