

Pavilion AV2, AV4 & AV13

Anderssen & Voll

2018

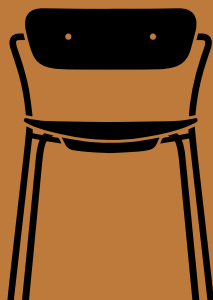



AV2 & AV4

Recycling & Disassembly

Pavilion^{AV2 & AV4}

RECYCLING

The Pavilion chair is built to last, and we hope that your Pavilion will serve you for many years. The chair is made from wood veneer and powder coated steel, and can be easily separated from its base. All metal and wooden parts can be separated and delivered to a suitable recycling station.

SPARE PARTS

To purchase spare parts for your Pavilion chair, please write to our sales support team at info@andtradition.com with your query.

5 YEAR WARRANTY

&Tradition provides a 5-year warranty with every Pavilion chair, which covers faults which were present at the time of purchase, or which have occurred as a result of a manufacturing defect. The warranty is valid from the date stated on the original invoice.

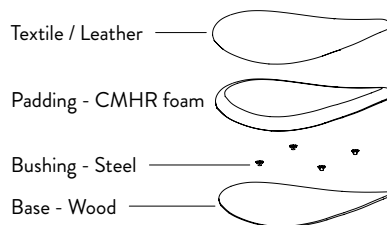
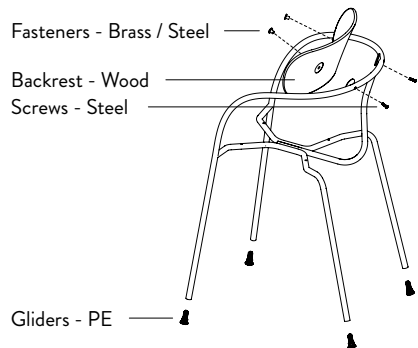
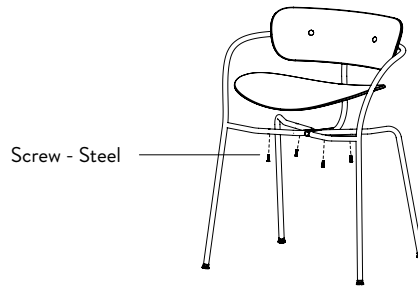
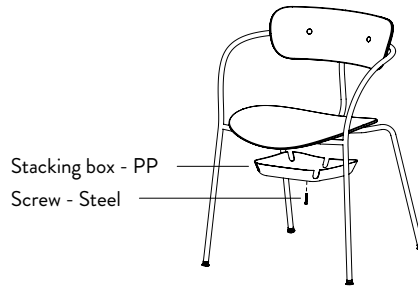

DISASSEMBLY

Disassembling of Pavilion chair

1. Unscrew the screw underneath the plastic shell.
2. Unscrew the screws underneath the chair to remove the seat.
3. Unscrew the screws behind the back of the chair, to remove the backrest and fasteners.
4. Remove the gliders.

Disassembling of upholstered seat (AV4 only)

Remove the textile, padding and bushings from the wooden base of the seat.



AV12

Recycling & Disassembly

Pavilion^{AV12}

RECYCLING

The Pavilion chair is built to last, and we hope that your Pavilion will serve you for many years. The chair is made from wood veneer and powder coated steel, and can be easily separated from its base. All metal and wooden parts can be separated and delivered to a suitable recycling station.

SPARE PARTS

To purchase spare parts for your Pavilion chair, please write to our sales support team at info@andtradition.com with your query.

5 YEAR WARRANTY

&Tradition provides a 5-year warranty with every Pavilion chair, which covers faults which were present at the time of purchase, or which have occurred as a result of a manufacturing defect. The warranty is valid from the date stated on the original invoice.

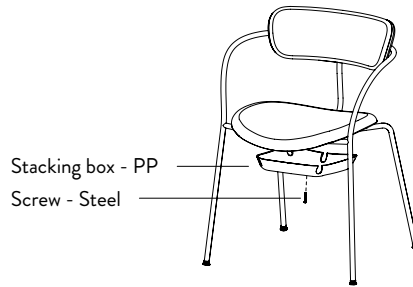

Stacking box - PP
Screw - Steel

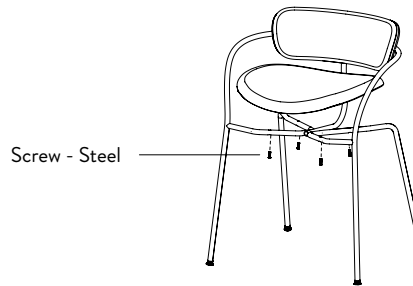

Screw - Steel

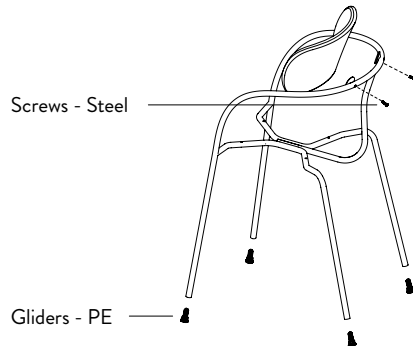

Screws - Steel

Gliders - PE

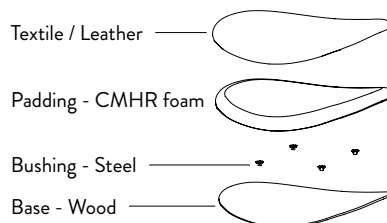

Textile / Leather

Padding - CMHR foam

Bushing - Steel

Base - Wood

DISASSEMBLY

Disassembling of Pavilion chair

1. Unscrew the screw underneath the plastic shell.
2. Unscrew the screws underneath the chair to remove the seat.
3. Unscrew the screws behind the back of the chair, to remove the backrest.
4. Remove the gliders.

Disassembling of upholstered seat & backrest

1. Remove the textile, padding and bushings from the wooden base of the seat.
2. Do the same with the backrest of the chair.

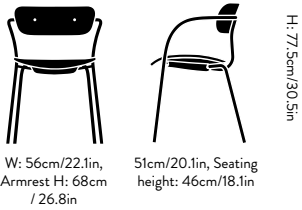

Pavilion^{AV2}

Anderssen & Voll

2018

Product category

Stackable chair with armrest

Environment

Indoor

Material

Steel tubes and formpressed veneer.

This product has not been treated with any biocides.

Production process

The chair is made from bend steel tubes and formpressed veneer. The veneer back and seat are finished with a PU lacquer. All chairs are equipped with an injection molded plastic stacking tray underneath the seat.

Dimensions

H: 76.5cm/30.1in, W: 56cm/22.1in, D: 50cm/19.7in, Seating height: 46cm/18.1in, Armrest H: 68cm / 26.8in

Package dimensions

H: 89cm/35in, W: 59cm/23.2in, D: 59cm/23.2in

Colli quantity

2 pcs

Weight

Product: 5.4 kg / Incl.packaging: 13 kg

Colours

Lacquered Oak, Black Lacquered Oak and Lacquered Walnut.

Base & fittings finishes

Black: Black Fittings for the front side of the back rest installed as standard. Brass & Chrome fittings available upon request.

Chrome base: Chrome fittings for the front side of the back rest installed as standard. Brass & Black fittings available upon request.

→ Stock item

Black base & black fittings with Lacquered Oak, Black Lacquered Oak or Lacquered Walnut

Gliders

Plastic gliders installed as standard. Felt gliders available upon request (6-8 weeks lead time)

Stacking quantity

With trolley: 10 pcs

Without trolley: 8 pcs

Strength, Durability and Safety Testing

The chair is tested for strength, durability and safety according to; EN 16139 Level 2 – Extreme use.

Manufacturer

Produced in Latvia by Kvist Industries A/S

Cleaning Instructions

Please download our Material Care & Cleaning Instructions through www.andtradition.com



Brass fitting

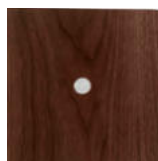

Chrome fitting



Black fitting



Black base



Chrome base



→Black lacquered oak, black base & black fittings



→Lacquered oak, black base & black fittings



→Lacquered walnut, black base & black fittings

Related products

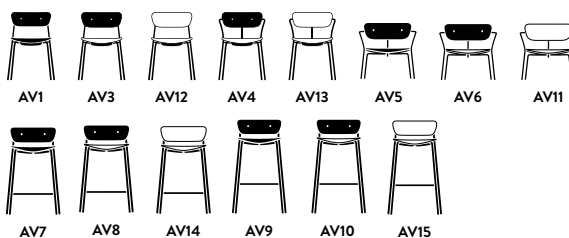

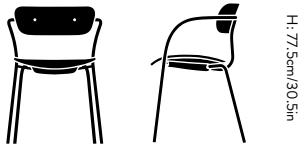

W: 56cm/22.1in,
Armrest H: 68cm
/ 26.8in

51cm/20.1in, Seating
height: 46cm/18.1in

H: 77.5cm/30.5in

Pavilion^{AV4} Anderssen & Voll 2018

Product category

Stackable chair with armrest

Environment

Indoor

Material

Steel tubes and formpressed veneer. HR foam.

Fabric or leather upholstery.

This product has not been treated with any biocides.

Production process

The chair is made from bend steel tubes and formpressed veneer. The veneer back is finished with a PU lacquer. The seat is covered with HR foam and upholstery for superior comfort. All chairs are equipped with an injection molded plastic stacking tray underneath the seat.

Dimensions

H: 76.5cm/30.1in, W: 56cm/22.1in, D:
50cm/19.7in, Seating height: 46cm/18.1in,
Armrest H: 68cm / 26.8in

Package dimensions

H: 89cm/35in, W: 59cm/23.2in, D: 59cm/23.2in

Colli quantity

2 pcs

Weight

Product: 5.6 kg / Incl.packaging: 12 kg

Colours

Lacquered Oak, Black Lacquered Oak and
Lacquered Walnut.

COM – Material Consumption

Fabric usage: 0.45 meters based on 140cm roll.

Leather usage: 0.55 square meters. COM must
be approved by &Tradition to ensure suitability for
upholstery.

Base & fittings finishes

Black: Black Fittings for the front side of the back
rest installed as standard. Brass & Chrome fittings
available upon request.

Chrome base: Chrome fittings for the front side of
the back rest installed as standard. Brass & Black
fittings available upon request.

Gliders

Plastic gliders installed as standard. Felt gliders
available upon request (6-8 weeks lead time)

Stacking quantity

With trolley: 10 pcs

Without trolley: 8 pcs

Strength, Durability and Safety Testing

The chair is tested for strength, durability and safety
according to; EN 16139 Level 2 – Extreme use.

Manufacturer

Produced in Latvia by Kvist Industries A/S

Cleaning Instructions

Please download our Material Care & Cleaning
Instructions through www.andtradition.com



Brass fitting

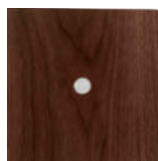

Chrome fitting



Black fitting



Black base



Chrome base



→Black lacquered
oak



→Lacquered oak



→Lacquered
walnut

Related products

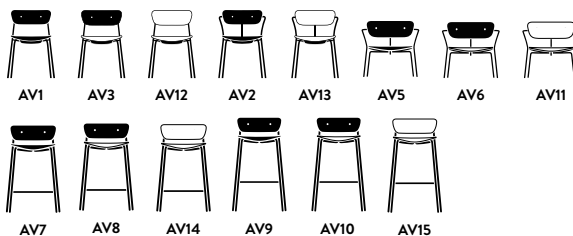



W: 56cm/22.1in,
Armrest H: 68cm
/ 26.8in



51cm/20.1in, Seating
height: 46cm/18.1in

H: 77.5cm/30.5in

Pavilion^{AV13} Anderssen & Voll 2018

Product category

Stackable chair with armrest

Environment

Indoor

Material

Steel tubes and formpressed veneer. HR foam.

Fabric upholstery.

This product has not been treated with any biocides.

Production process

The chair is made from bend steel tubes and formpressed veneer. The back rest and seat is covered with HR foam for superior comfort. All chairs are equipped with an injection molded plastic stacking tray underneath the seat.

Dimensions

H: 76.5cm/30.1in, W: 56cm/22.1in, D:
50cm/19.7in, Seating height: 46cm/18.1in,
Armrest H: 68cm / 26.8in

Package dimensions

H: 89cm/35in, W: 59cm/23.2in, D: 59cm/23.2in

Colli quantity

2 pcs

Weight

Product: 5.6 kg / Incl.packaging: 12kg

COM – Material Consumption

Fabric usage: 0.9 meter based on a 140cm roll.

COM must be approved by &Tradition to ensure suitability for upholstery.

Pavilion AV13 is not available in leather.

Base

Black or Chrome base.

Gliders

Plastic gliders installed as standard. Felt gliders available upon request (6-8 weeks lead time)

Stacking quantity

With trolley: 10 pcs

Without trolley: 8 pcs

Strength, Durability and Safety Testing

The chair is tested for strength, durability and safety according to; EN 16139 Level 2 – Extreme use.

Manufacturer

Produced in Latvia by Kvist Industries A/S

Cleaning Instructions

Please download our Material Care & Cleaning Instructions through www.andtradition.com



Black base



Chrome base

Related products

