

UTOPIA

Daide Groppi / 2023



Utopia is a project on the limit state of light,
the research for the minimum dimension necessary
for pure and essential lighting.

It represents full flexibility, in both its design and its light control.
The light strip reaches into space, bending and drawing abstract, mysterious patterns.
Luminaire designed also to be powered by ENDLESS conductive tape.

Utopia è un progetto sullo stato limite della luce,
alla ricerca della dimensione minima necessaria
per illuminare in modo puro ed essenziale.

Rappresenta la massima flessibilità,
sia nel disegno della linea che nella gestione della luce.
Il nastro luminoso si tende nello spazio, piegandosi, disegnando grafi astratti e misteriosi.
Apparecchio illuminante alimentabile anche con il tape conduttivo ENDLESS.

Linear version - UTOPIA 6

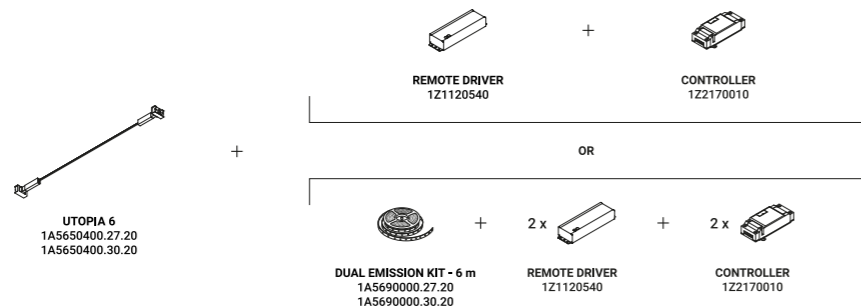

Linear version - UTOPIA 12

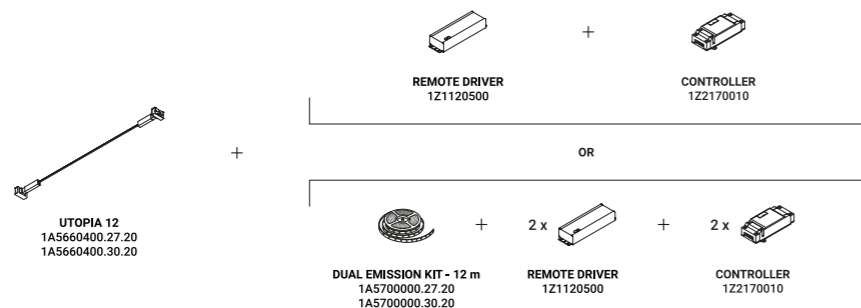

Bent version

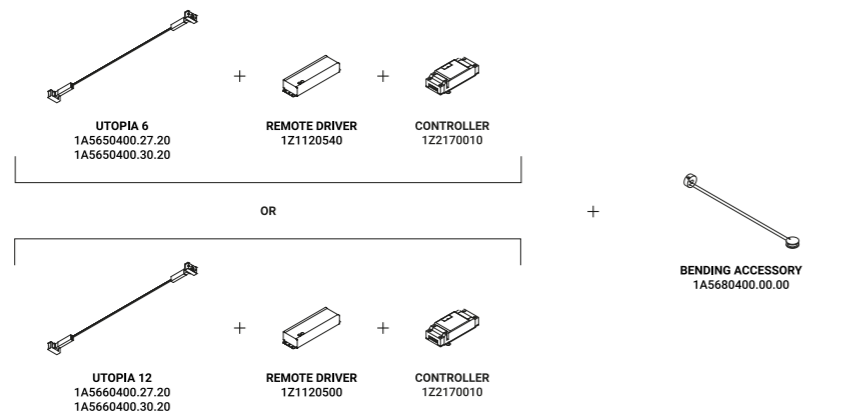

Systems / Indirect / Indoor

Material Metal
Finish .04 Matt Black

Note Special stainless steel profile stretched from wall to wall, only 3 mm thick. Available in 6 / 12 m with a single power unit and uniform lighting. Possibility to bend the profile in the space. Recommended installation height is 2,3 m from the floor. Possibility for the luminaire to be powered by ENDLESS conductive tape and by dedicated voltage/current (Max 48V DC - Max 150W - Max 4A).

Speciale profilo in acciaio inox teso da parete a parete di soli 3 mm di spessore. Disponibile da 6 / 12 m con un'unica alimentazione e illuminamento uniforme. Possibilità di piegare il profilo nello spazio. Altezza di installazione consigliata superiore a 2,3 m dal pavimento. Alimentabile anche con il tape conduttivo ENDLESS e tensione/corrente dedicata (Max 48V DC - Max 150W - Max 4A).

UTOPIA 6
72W
24V DC
2700K - 6084lm / 3000K - 6342lm
CRI >90
Driver not included
CE IP20 ENEC

Matt Black - 2700K
Matt Black - 3000K

1A5650400.27.20
1A5650400.30.20

UTOPIA 12
144W
24V DC
2700K - 12168lm / 3000K - 12684lm
CRI >90
Driver not included
CE IP20 ENEC

Matt Black - 2700K
Matt Black - 3000K

1A5660400.27.20
1A5660400.30.20

Compulsory accessories / Accessori obbligatori

Drivers / Alimentatori

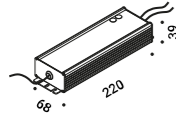

Driver / Alimentatore				Not included
100-240V	24V/96W/IP67/1-10V	UTOPIA 6	1Z1120540	

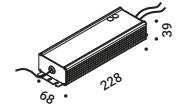

Driver / Alimentatore				Not included
100-240V	24V/150W/IP67/1-10V	UTOPIA 12	1Z1120500	

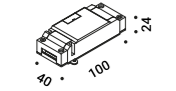

Controller			Not included
	DALI - PUSH - 0/1-10V - TRIAC - IP20	1Z2170010	

Optional accessories / Accessori opzionali

Installation kits / Kit d'installazione

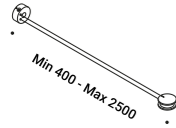

Bending accessory / Accessorio di piega			Not included
Matt Black	Not for dual emission kits	1A5680400.00.00	



Spacer / Distanziale			Not included
Matt Black		1A4930400.00.00	

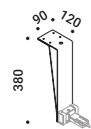

Ceiling installation kit / Kit d'installazione da soffitto			Not included
Matt White		1A0080300.00.00	
Matt Black		1A0080400.00.00	

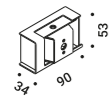

Kit wall connection sloped right 75° / Kit attacco da parete per inclinazione 75° destro			Not included
Matt Black		1A5710400.00.00	

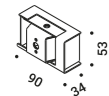

Kit wall connection sloped left 75° / Kit attacco da parete per inclinazione 75° sinistro			Not included
Matt Black		1A5720400.00.00	

The sizes are expressed in millimeters.

Optional accessories / Accessori opzionali

Installation kits / Kit d'installazione



Kit 6 m for dual emission / Kit 6 m per doppia emissione				Not included
Standard	Input 24V DC - 72W - IP20 2700K - 6084lm - CRI >90 Not bendable	UTOPIA 6	1A5690000.27.20	

Standard	Input 24V DC - 72W - IP20 3000K - 6342lm - CRI >90 Not bendable	UTOPIA 6	1A5690000.30.20	
----------	---	----------	-----------------	--

Kit 12 m for dual emission / Kit 12 m per doppia emissione				Not included
---	--	--	--	--------------

Standard	Input 24V DC - 144W - IP20 2700K - 12168lm - CRI >90 Not bendable	UTOPIA 12	1A5700000.27.20	
----------	---	-----------	-----------------	--

Standard	Input 24V DC - 144W - IP20 3000K - 12684lm - CRI >90 Not bendable	UTOPIA 12	1A5700000.30.20	
----------	---	-----------	-----------------	--

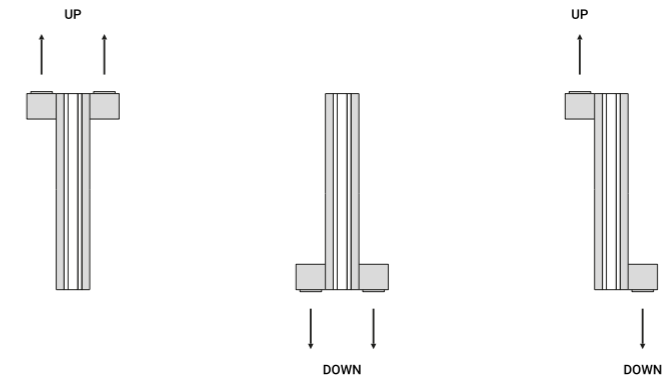

Possibilities of strip LED installation for dual emission | **Not bendable only**

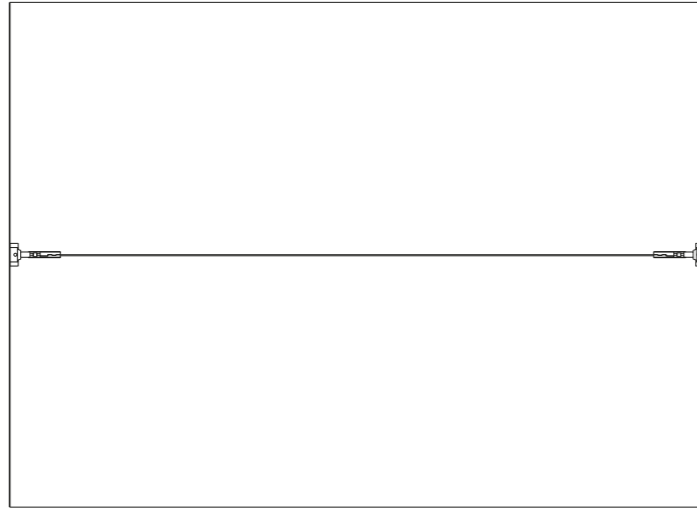

Example of linear installation

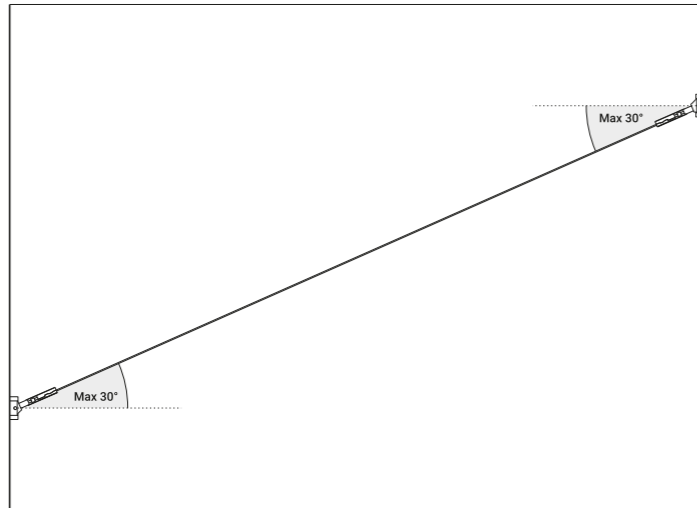

Example of installation with max rotation 30°

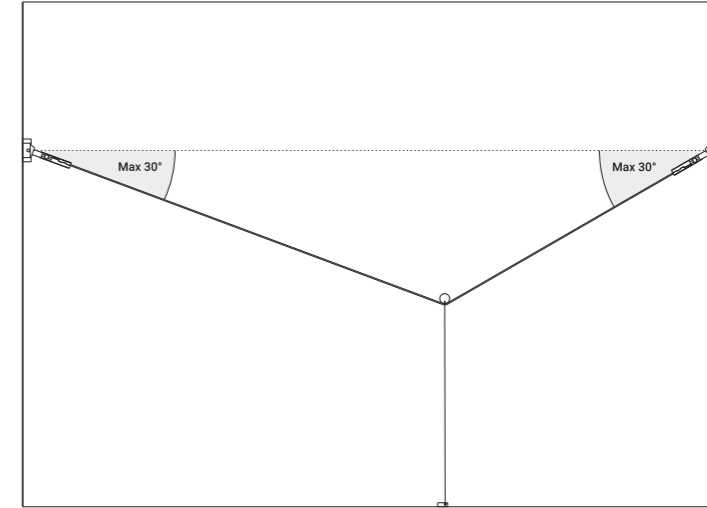

1A5680400.00.00 - Example of installation with bending accessory

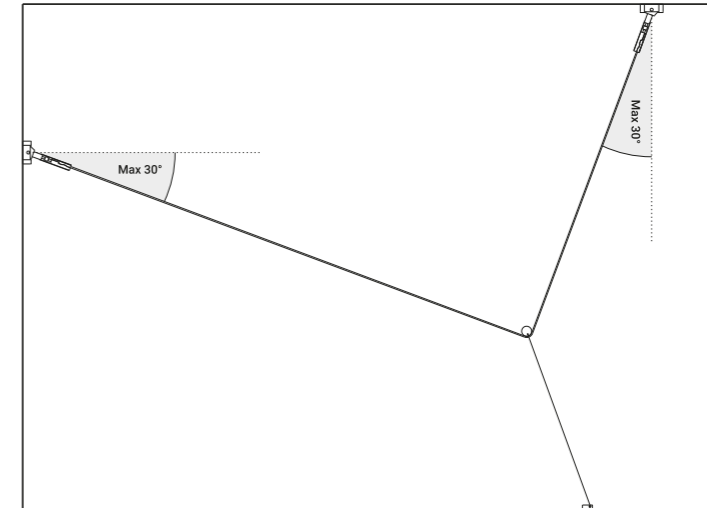

1A5680400.00.00 - Example of installation with bending accessory

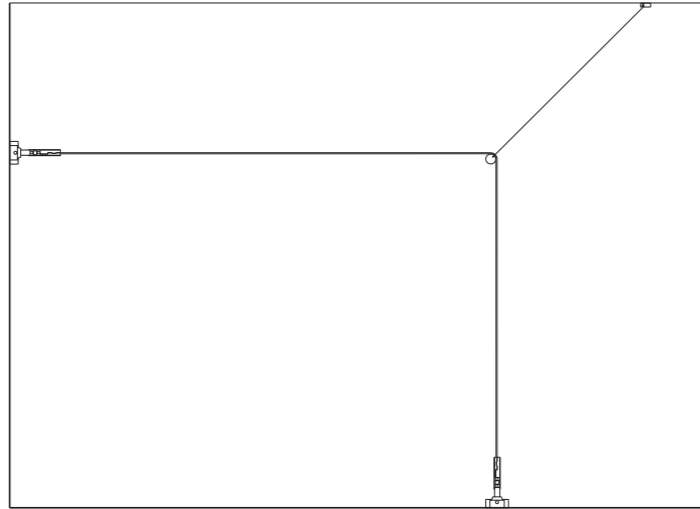

1A5680400.00.00 - Example of installation with bending accessory

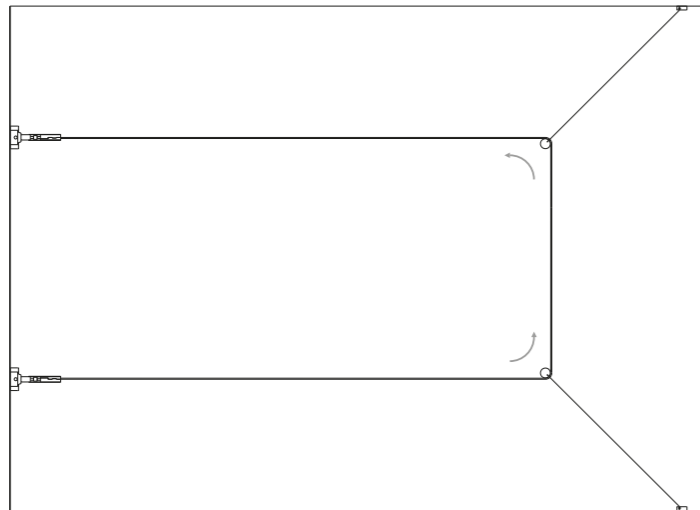

1A5680400.00.00 - Example of installation with bending accessory

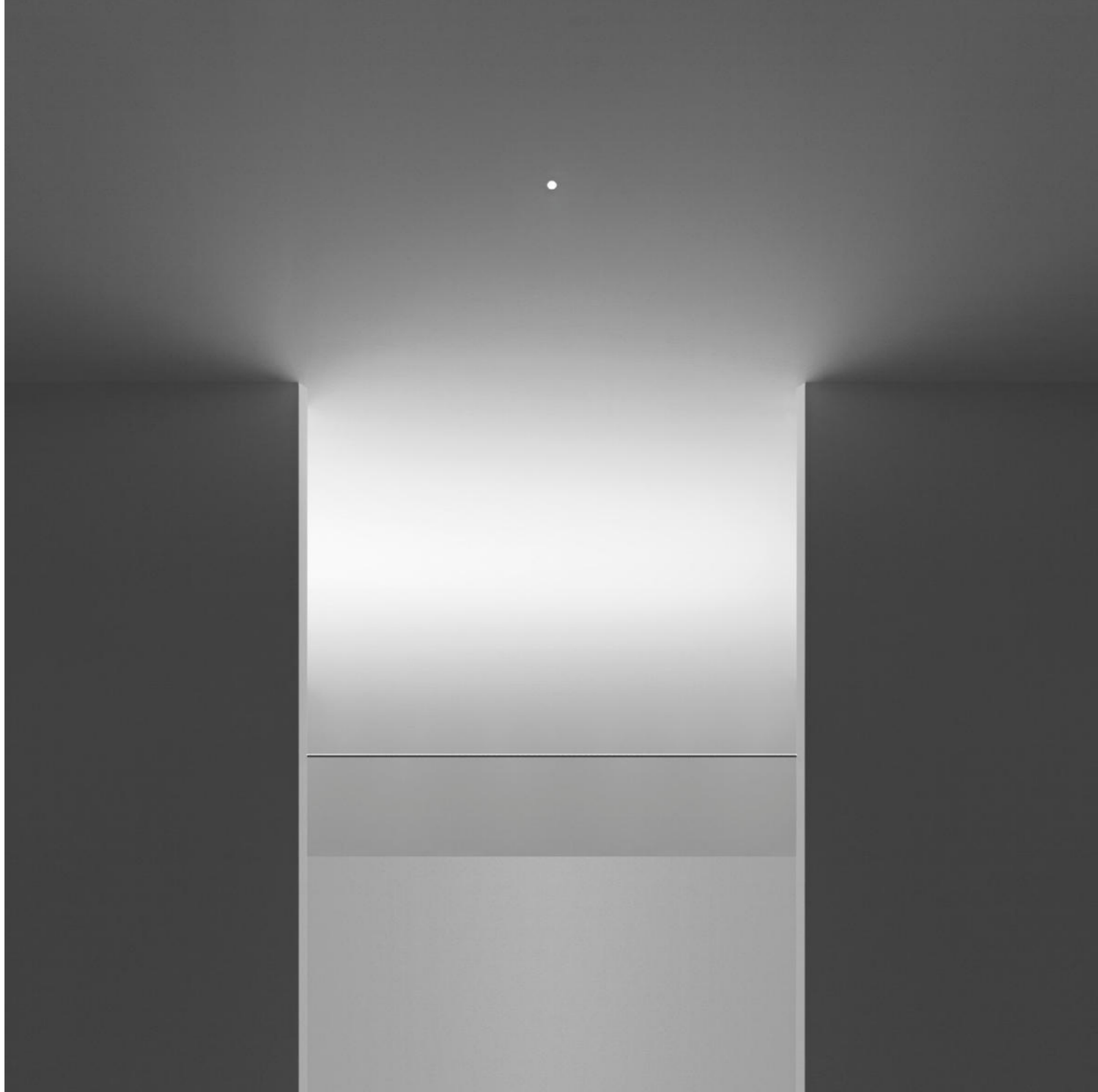



only 3 mm