

PLUS

Francesco Rota | 2017



PLUS

Francesco Rota | 2017

They look for and attract each other. This combination of shapes and colours gives rise to PLUS sofas, a system of modular elements that enhance the character of all community spaces. The profile is soft and the seat is generously wide enough to accommodate the body lying down. A host of solutions can be found, thanks to an extremely simple linking system that re-arranges shapes and redefines the profile. A small but important world for gathering at home, in the office or in any space. And when you want a moment to yourself, the SCREEN panel, which can be used as a backrest, creates a very discreet area.





Classic curved

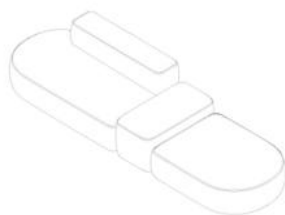

Classic curved – medium

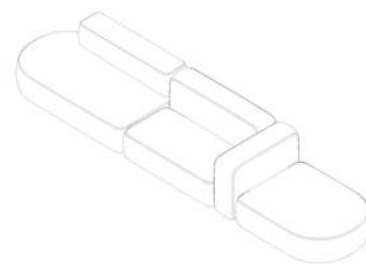

Classic curved – big

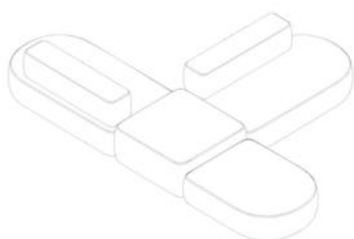

T_shape

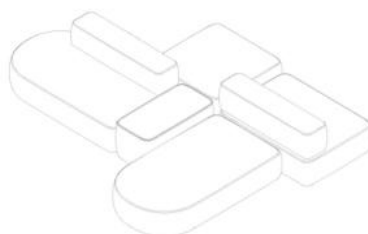

Island

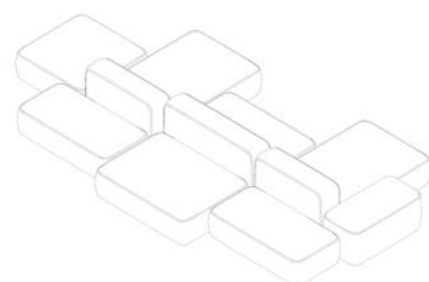

Island – big

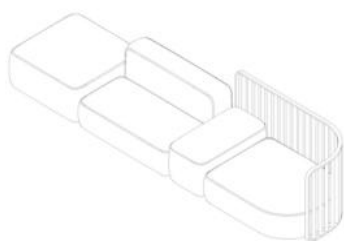

Classic curved – big + screen

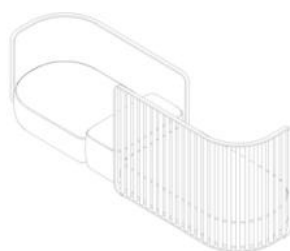

Vis-à-vis

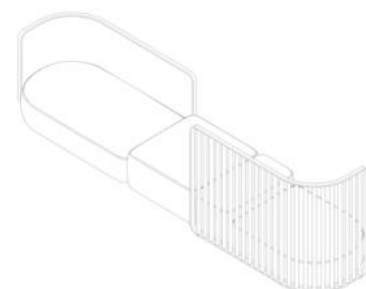

Vis-à-vis – big

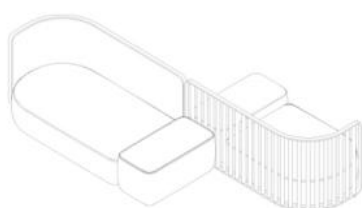

S_shape

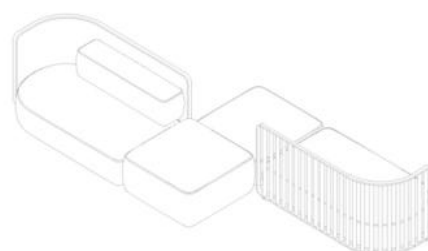

S_shape – medium

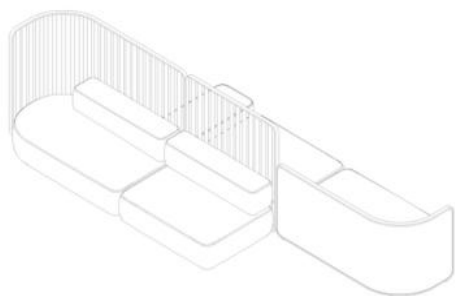

S_shape — big

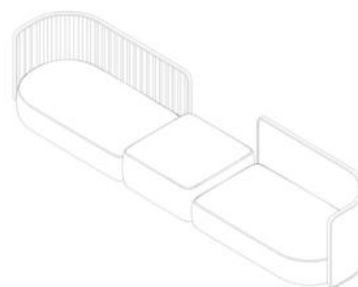

Side by side

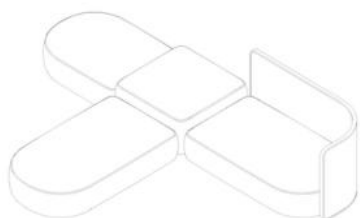

T_shape + screen

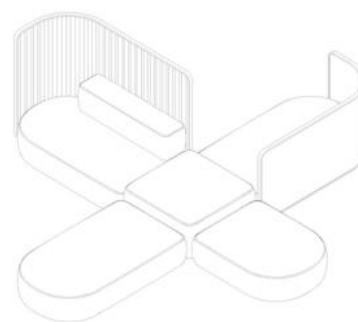

X_shape + screen

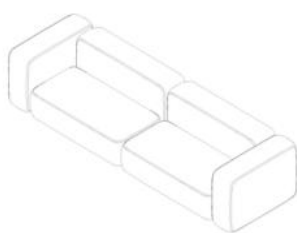

Classic

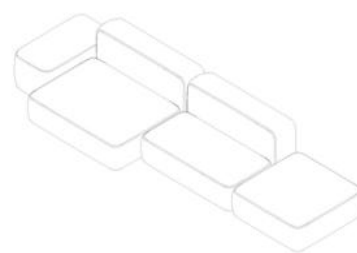

Classic — medium

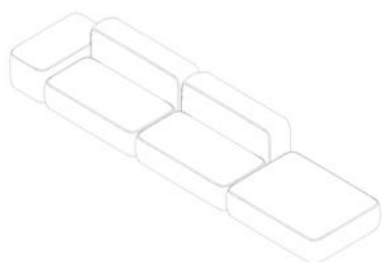

Classic — big

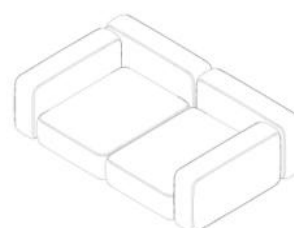

Classic — deep

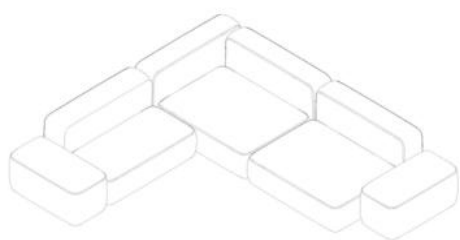

L_shape

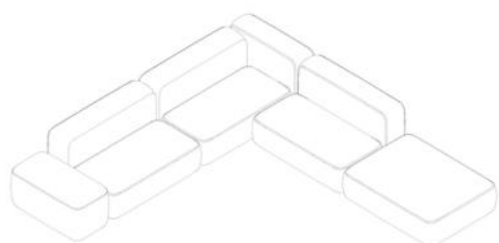

L_shape - 2

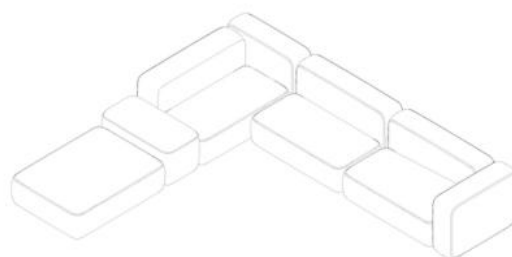

L_shape - 3

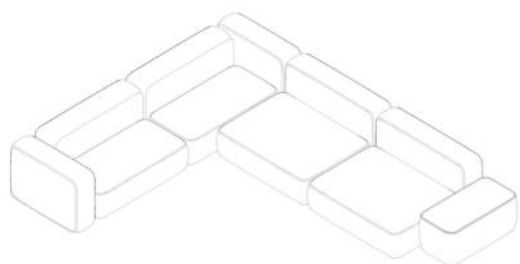

L_shape - 4

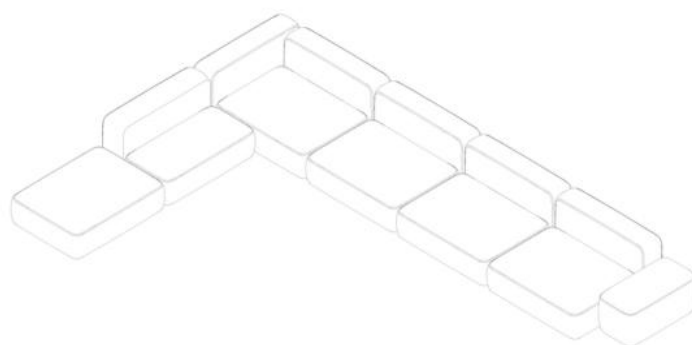

L_shape - 5

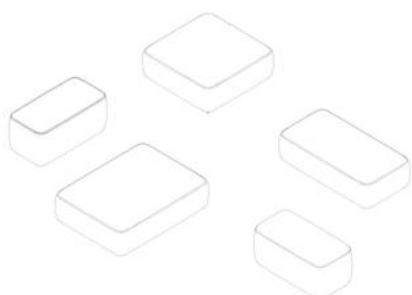

Pouf

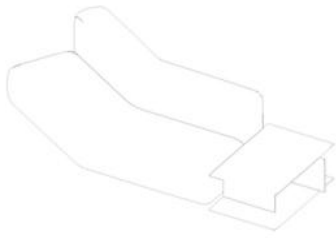

V-shape - 1

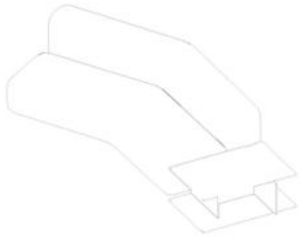

V-shape - 2

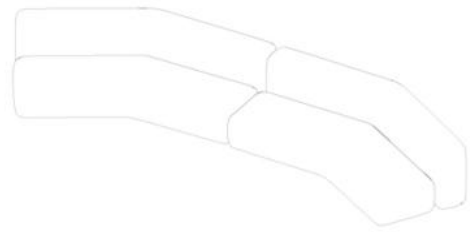

U-shape

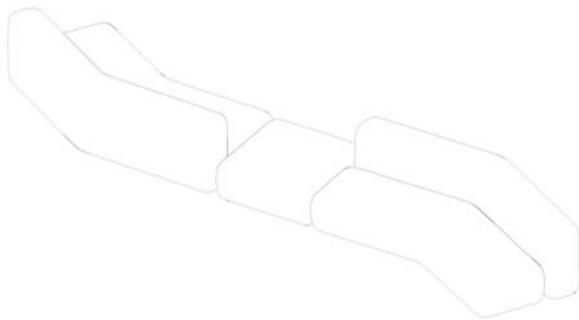

S-shape

PLUS

Francesco Rota | 2017

Modular seating in fire-retardant injected foam with removable fabric. Seats, backrests and armrest, also with hpl or wooden top, can be linked with brackets. PLUS can be matched with SCREEN partitions and OORT cushions.

TEST EN 1728:2012 AC:2013 6.17 - EN 16139:2013 - L2 extreme

TEST 1 IM - Hallingdal, Maya, Tonica

seats



94
37"

94
37"

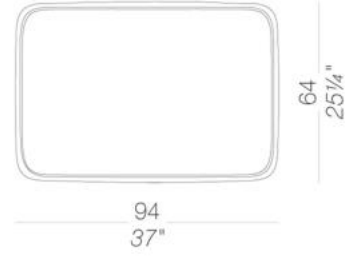
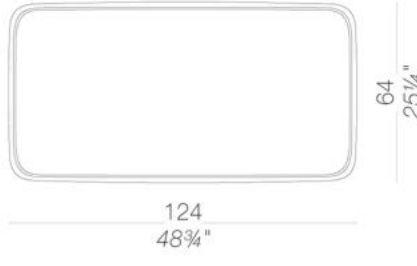

124
48 3/4"

124
48 3/4"

94
37"



164
64 1/2"

118
46 1/2"

PLUS

Francesco Rota | 2017

seats

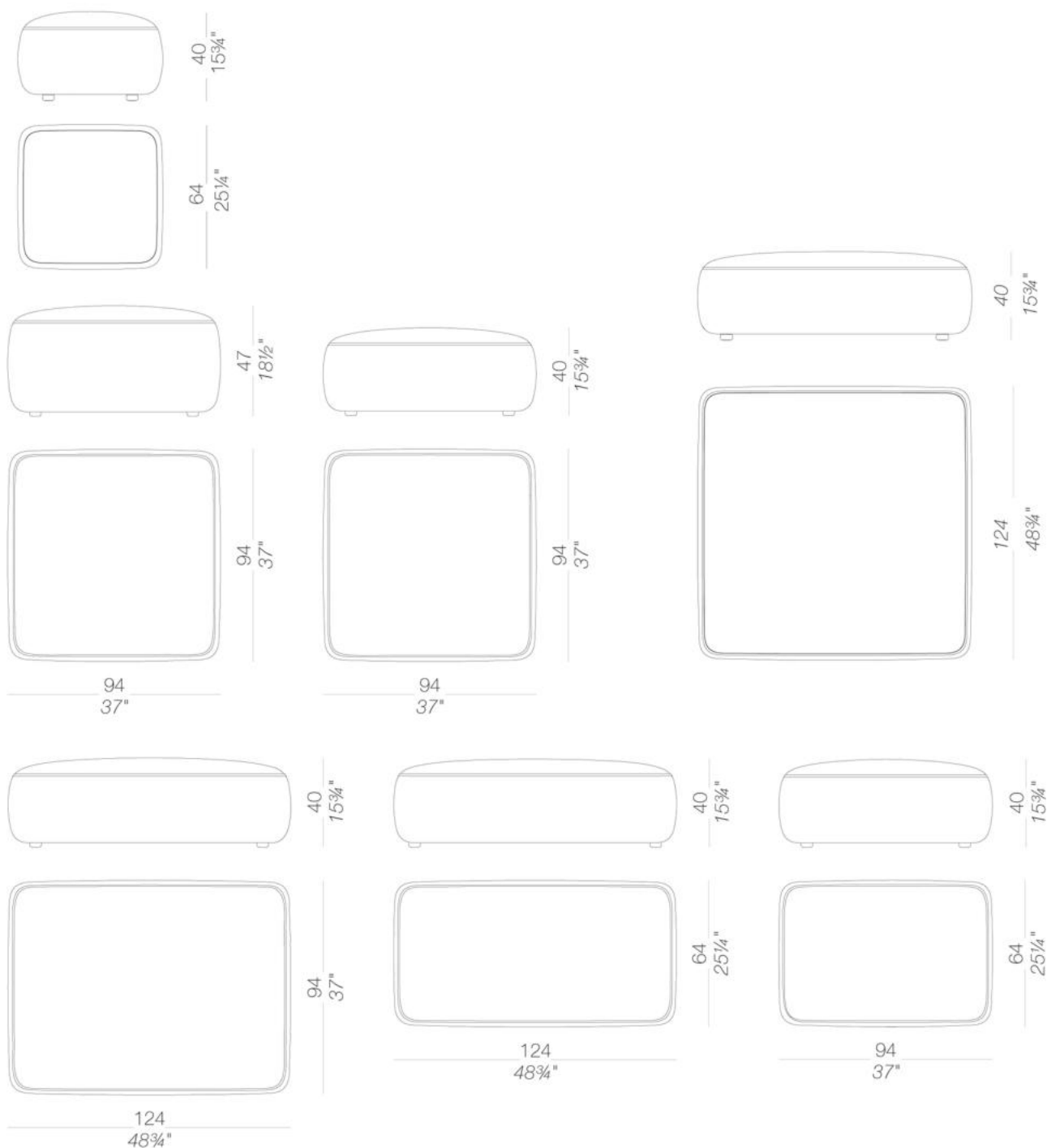

PLUS

Francesco Rota | 2017

seats

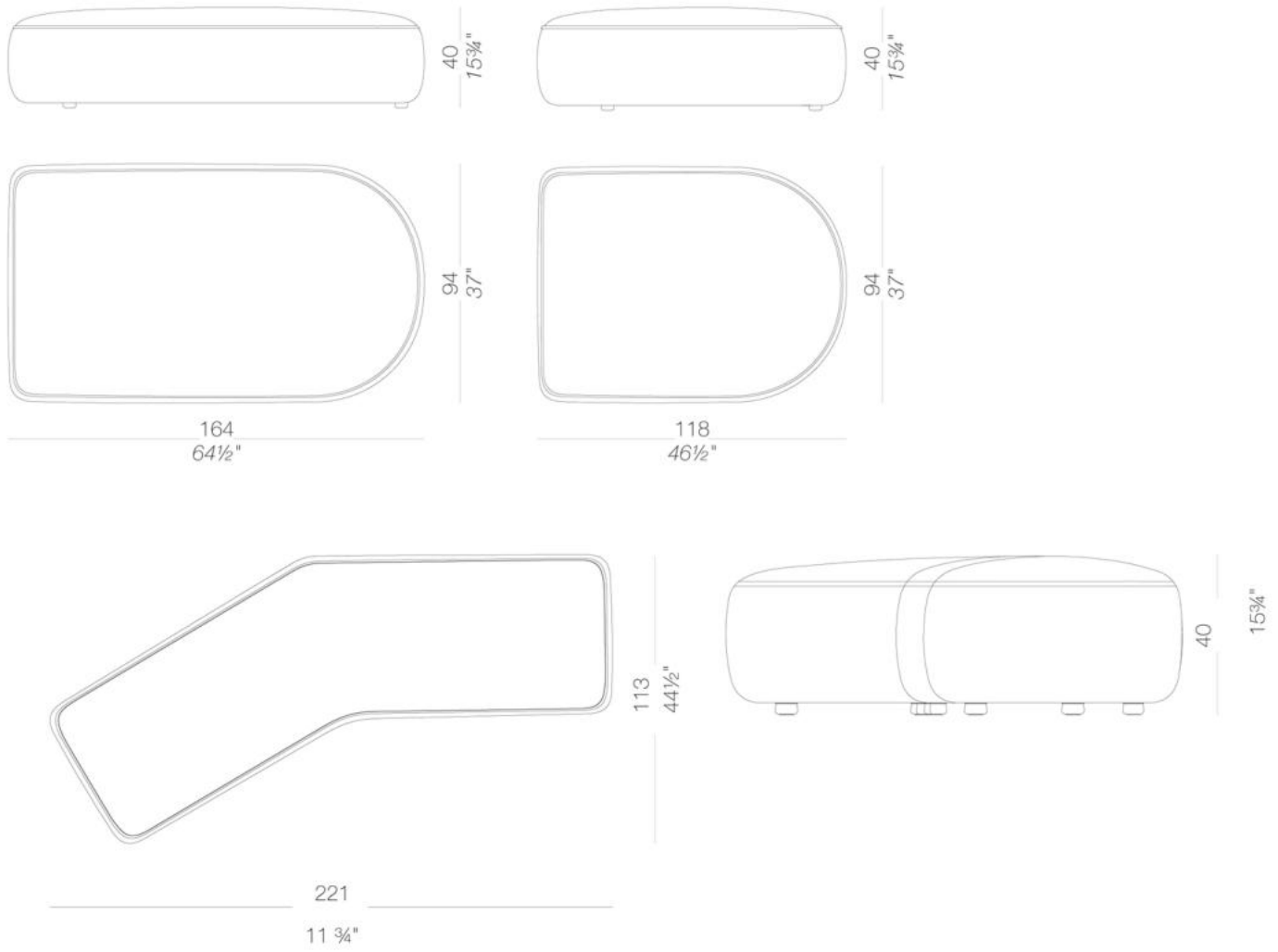

PLUS

Francesco Rota | 2017

backrests

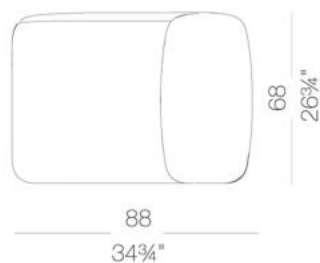
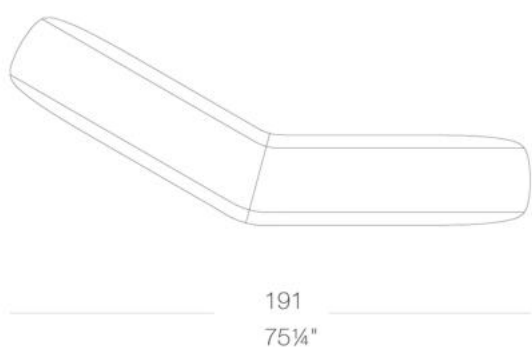
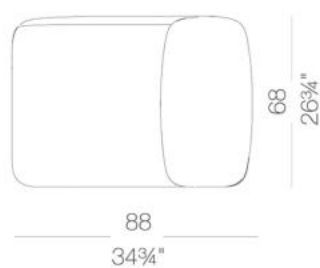
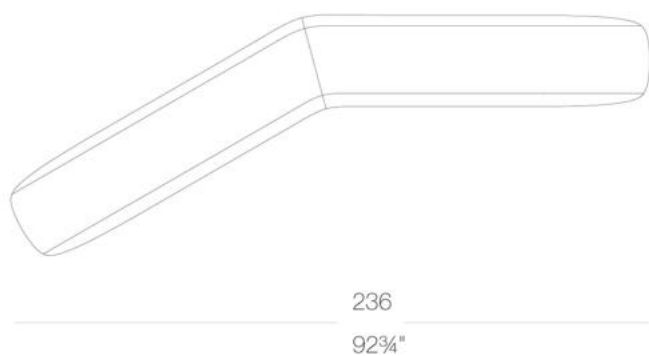
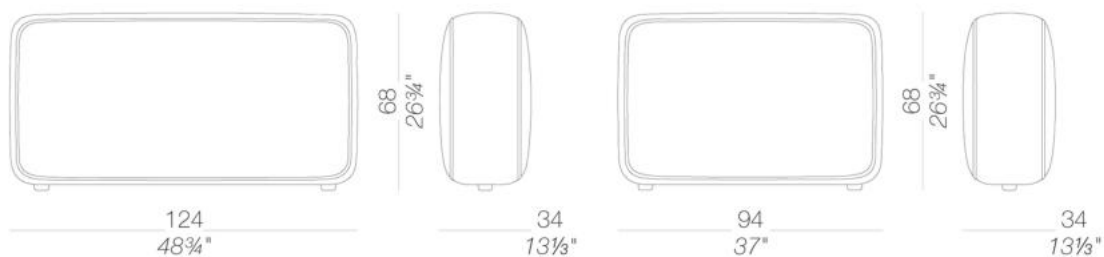

loose backrest



armrest

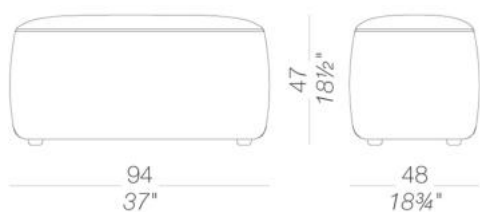

PLUS

Francesco Rota | 2017

small table



PLUS

Francesco Rota | 2017

upholstery



fabric
Main Line Flax -
Grade. B
57 Colors



fabric
Blazer - Grade. C
77 Colors

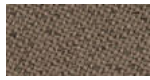

fabric
Chili - Grade. A
47 Colors



fabric
Umber - Grade. B
36 Colors



fabric
Nobel - Grade. C
30 Colors



fabric
Naveli - Grade. C
24 Colors



fabric
Fiocco - Grade. B
34 Colors



fabric
Atrium - Grade. C
16 Colors



fabric
Panama - Grade. A
48 Colors



fabric
Sorrento - Grade. B
22 Colors



fabric
Hallingdal 65 - Grade
C
58 Colors



fabric
Canvas 2 - Grade C
45 Colors

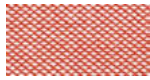

fabric
Steelcut Trio 3 -
Grade D
54 Colors

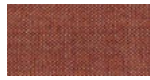

fabric
Remix 3 - Grade C
72 Colors



fabric
Divina MD - Grade D
27 Colors



fabric
Divina Melange 3 -
Grade D
38 Colors



fabric
Medley - Grade A
37 Colors



fabric
Maya - Grade A
43 Colors



fabric
Jet - Grade A
66 Colors



fabric
Fiord 2 - Grade C
39 Colors



fabric
Tonica 2 - Grade C
39 Colors

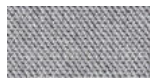

fabric
Capture - Grade B
60 Colors



fabric
Crisp - Grade B
40 Colors



fabric
Iliris - Grade B
34 Colors



soft-leather
Soft-leather
17 Colors



fabric
Steelcut 3 - Grade D
40 Colors



ecoleather
Valencia - Grade B
72 Colors



soft-leather
soft-leather
7 Colors



HPL 10 mm
HPL fenix
2 Colors



HPL 10 mm
HPL fenix
2 Colors



fabric
Grain - Grade. B
50 Colors

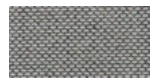

fabric
Re-wool - Grade C
24 Colors

frame



HPL 10 mm
white HPL fenix
1 Colors



HPL 10 mm
black HPL fenix
1 Colors



HPL 10 mm
HPL fenix grigio
Londra
1 Colors



HPL 10 mm
HPL fenix rosso
Jaipur
1 Colors

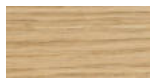

wood
blached oak
1 Colors

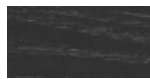

wood
black open pore
1 Colors

top



HPL 10 mm
HPL fenix
2 Colors



wood
blached oak
1 Colors



HPL 10 mm
HPL fenix
2 Colors



wood
black open pore
1 Colors

linking bracket



metal
aluminium
1 Colors

consult the portfolio for the range of colors, fabrics, eco-leather, soft-leather.

use and maintenance instructions

Clean all parts in wood, leather, fabric and metal with a damp cloth or a diluted neutral cleaner. Do not use cleaners with alcohol,

bleach, solvent or abrasive products. Any liquid spilt on the product must be wiped up immediately. When lifting or moving the product, hold it on the structure and not under the seat. The product should not be subjected to unbalanced weights, as it is designed for a proper rest on the foothold (on four legs or on the base). Our company relieves from any responsibility in case of damage caused to fragile floors. Avoid any improper use of the product: do not step on the product, on the footrest or on the armrests. Avoid any movements that could compromise the proper functionality of the product or the safety of the users. Wood and leather, being natural materials, could be easily damaged. Small impurities or imperfections are within quality standard range. Do not expose the product to weather conditions or atmospheric agents, nor to heat sources over 40°C. Also products for outdoor use could be afflicted by atmospheric agents. The product could undergo possible exterior changes due to particular exposure to heat, humidity and saltiness. An appropriate and frequent maintenance and cleaning of the product enhances its durability. The product could change colour and shade, if exposed to direct sunlight. Maintenance has to be carried out by experienced staff. Dispose of the package only after assembling the product, in order to avoid the loss of ironmongery and components. Once the product has been dismantled, the product itself or its components must be given to the public garbage disposal system, according to the legislation in force.